

Intelligent protection board for lithium battery

Operation and maintenance instructions

Product warranty terms

Product Name: battery active equalizer

Warranty period: one year

1 Overview

The intelligent protection board of lithium battery is a management system specially designed for large-capacity series lithium battery packs. which has the functions of voltage acquisition, high current active balance, overcharge, over discharge, over current and over temperature protection, coulomb counter, Bluetooth communication, GPS remote, etc. It can be applied to lithium iron phosphate, ternary lithium and other battery types.

Based on the energy transfer active balance technology with independent intellectual property rights, the protection board can achieve the maximum continuous 2A balance current. High current active balance technology can guarantee the battery consistency, improve the battery life and delay the battery aging to the greatest extent.

The protection board has a supporting mobile app, supporting Android and IOS operating systems. The app can be connected to the protection board via Bluetooth to check the battery working status, modify the working parameters of the protection board, control the switch of charging and discharging, etc. The protection panel is small in size, simple in operation and full in function, which can be widely used in battery pack of small sightseeing bus, scooter, shared car, high-power energy storage, base station standby power supply, solar power station and other products.

2 Main Technical Parameters

2.1 Main Technical Indicators

The main technical indicators of the protection board are shown in Table 1.

Table 1. Main technical indicators of protection board

Technical index	Product model						
	BD6A17S6P	BD6A20S6P	BD6A20S10P	BD6A24S10P	B1A24S15P	B2A24S15P	B2A24S20P
Number of battery strings	13~17	13~20	13~20	13~24	13~24	13~24	13~24

Number of battery strings	15~17	15~20	15~20	15~24	15~24	15~24	15~24
Number of battery strings	17	17~20	17~20	17~24	17~24	17~24	17~24
balance mode	Active balance	Active balance	Active balance	Active balance	Active balance	Active balance	Active balance
Equalizing current	0.6 A	0.6 A	0.6 A	0.6 A	1 A	2 A	2 A
Main circuit conduction internal	1.3 mΩ	1.3 mΩ	0.8mΩ	0.8mΩ	0.5mΩ	0.5mΩ	0.3mΩ
Continuous discharge current	60A	60A	100A	100A	150A	150A	200A
Maximum discharge current	100A	100A	200A	200A	300A	300A	350A
Charging overcurrent	10~60 A	10~60 A	10~100 A	10~100 A	10~150 A	10~150 A	10~200 A
Other interfaces (customized)	RS485	RS485	RS485	RS485	RS485/CAN	RS485/CAN	RS485/CAN
Entry cable	Same port						
Single voltage range	1~5 V						
Voltage acquisition	±5 mV						
Overcharge protection voltage	1.2~4.35 V adjustable						
Overcharge release voltage	1.2~4.35 V adjustable						
Discharge time of charging	2~120S adjustable						
Over discharge protection voltage	1.2~4.35 V adjustable						
Over discharge recovery voltage	1.2~4.35 V adjustable						
Number of temperature	3 个						
Temperature protection	yes						
Short circuit protection	yes						
Coulomb meter	yes						

Bluetooth function	Support Android and IOS
GPS remote (optional)	RS485/GPS

2.2 Application Enviroment

- a) Operating temperature range: - 20 °C ~ 70 °C;
- b) Power requirements: 40 ~ 100V.
- c) Power consumption: 10mA @ 100V in balanced state and 6mA @ 100V in unbalanced state.

3 Connector and Interface Description

3.1 Connector and LED Position Description

The positions of two types of protection board connectors and LED lights are shown in Figure 1 and Figure 2.

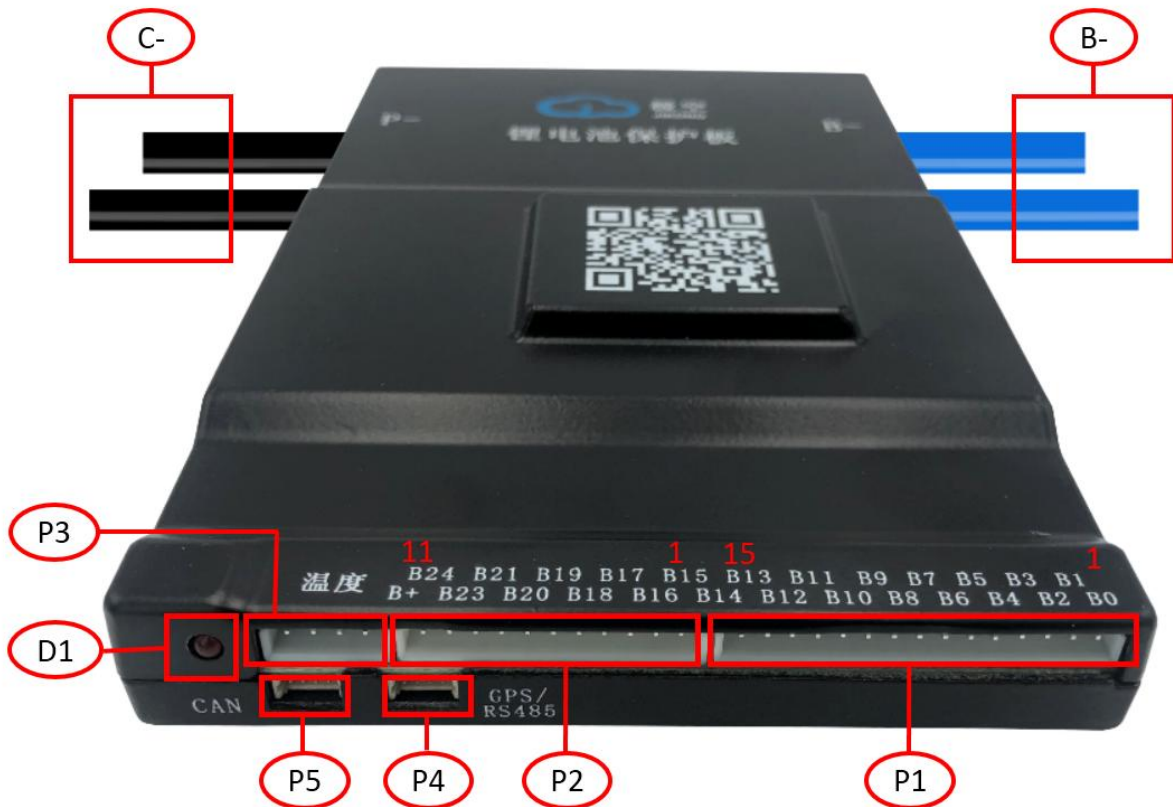

Figure 1. BD6A20S10P/B2A24S10P/ B1A24S15P/B2A24S15P/B2A24S20P
Connector Diagram

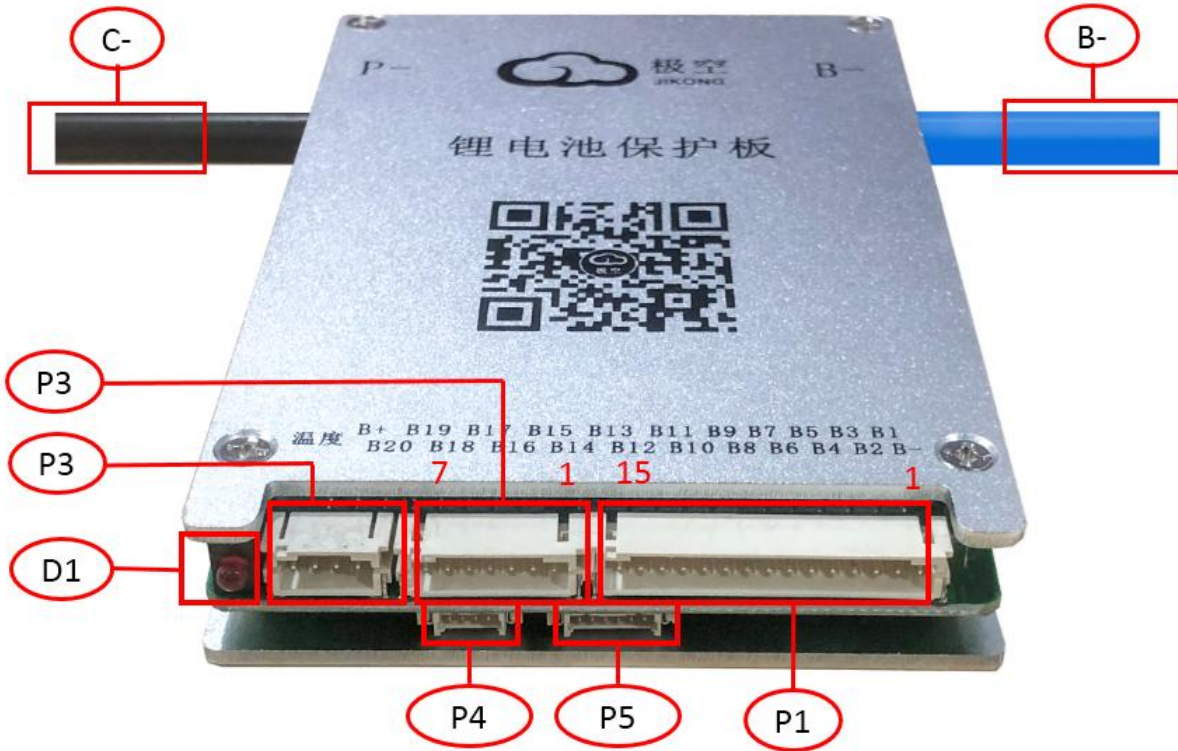

Figure 2. BD6A17S6P/BD6A20S6P
Connector Diagram

3.2 Connector and LED Definition Description

Table 2 BD6A20S10P、B2A24S10P、B1A24S15P、B2A24S15P、B2A24S20P for connector definition and LED light definition.

Table 2. Connector Definition

Connector	Pin No.	BD6A20S10P		B1A24S15P/B2A24S15P /B2A24S20P/BD6A24S10P	
		Name	Definition	Name	Definition
P1	1	B-	Total battery negative	B-	Total battery negative
	2	B1	Cell 1 Positive	B1	Cell 1 Positive
	3	B2	Cell 2 Positive	B2	Cell 2 Positive
	4	B3	Cell 3 Positive	B3	Cell 3 Positive
	5	B4	Cell 4 Positive	B4	Cell 4 Positive
	6	B5	Cell 5 Positive	B5	Cell 5 Positive
	7	B6	Cell 6 Positive	B6	Cell 6 Positive
	8	B7	Cell 7 Positive	B7	Cell 7 Positive
	9	B8	Cell 8 Positive	B8	Cell 8 Positive
	10	B9	Cell 9 Positive	B9	Cell 9 Positive

	11	B10	Cell 10 Positive	B10	Cell 10 Positive
	12	B11	Cell 11 Positive	B11	Cell 11 Positive
	13	B12	Cell 12 Positive	B12	Cell 12 Positive
	14	B13	Cell 13 Positive	B13	Cell 13 Positive
	15	B14	Cell 14 Positive	B14	Cell 14 Positive
P2	1	B15	Cell 15 Positive	B15	Cell 15 Positive
	2	B16	Cell 16 Positive	B16	Cell 16 Positive
	3	B17	Cell 17 Positive	B17	Cell 17 Positive
	4	B18	Cell 18 Positive	B18	Cell 18 Positive
	5	B19	Cell 19 Positive	B19	Cell 19 Positive
	6	B20	Cell 20 Positive	B20	Cell 20 Positive
	7	-	-	B21	Cell 21 Positive
	8	-	-	B22	Cell 22 Positive
	9	-	-	B23	Cell 23 Positive
	10	-	-	B24	Cell 24 Positive
	11	B+	Protection board power	B+	Protection board power
P3	1	T1A	1st temperature sensor A pin		
	2	T1B	1st temperature sensor B pin		
	3	T2A	2nd temperature sensor A pin		
	4	T2B	2nd temperature sensor B pin		
P4	External GPS interface or external RS485 converter interface				
P5	External CAN converter interface				
D1	Bluetooth connection indicator. When the protection board is connected to Bluetooth, the indicator is always on. When disconnected, the indicator blinks.				
C-	Connect external load or charger negative				
B-	Connected to electric core negative				

Table 3 BD6A17S6P、BD6A20S6P for connector definition and LED light definition.

Table 3. Connector Definition

Connector	Pin No.	BD6A17S6P		BD6A20S6P	
		Name	Definition	Name	Definition
P1	1	B-	Total battery negative	B-	Total battery negative
	2	B1	Cell 1 Positive	B1	Cell 1 Positive
	3	B2	Cell 2 Positive	B2	Cell 2 Positive
	4	B3	Cell 3 Positive	B3	Cell 3 Positive
	5	B4	Cell 4 Positive	B4	Cell 4 Positive
	6	B5	Cell 5 Positive	B5	Cell 5 Positive
	7	B6	Cell 6 Positive	B6	Cell 6 Positive

	8	B7	Cell 7 Positive	B7	Cell 7 Positive
	9	B8	Cell 8 Positive	B8	Cell 8 Positive
	10	B9	Cell 9 Positive	B9	Cell 9 Positive
	11	B10	Cell 10 Positive	B10	Cell 10 Positive
	12	B11	Cell 11 Positive	B11	Cell 11 Positive
	13	B12	Cell 12 Positive	B12	Cell 12 Positive
	14	B13	Cell 13 Positive	B13	Cell 13 Positive
	15	B14	Cell 14Positive	B14	Cell 14Positive
P2	1	B15	Cell 15 Positive	B15	Cell 15 Positive
	2	B16	Cell 16 Positive	B16	Cell 16 Positive
	3	B17	Cell 17 Positive	B17	Cell 17 Positive
	4	-	-	B18	Cell 18 Positive
	5	-	-	B19	Cell 19 Positive
	6	-	-	B20	Cell 20 Positive
	7	B+	Protection board power	B+	Protection board power
P3	1	T1A	1st temperature sensor A pin		
	2	T1B	1st temperature sensor B pin		
	3	T2A	2nd temperature sensor A pin		
	4	T2B	2nd temperature sensor B pin		
P4	External GPS interface or external RS485 converter interface				
P5	External Bluetooth module interface				
D1	The power indicator is always on when the protection board is powered on.				
C-	Connect external load or charger negative				
B-	Connected to electric core negative				

3.3 Product Appearance

BD6A20S10P、B2A24S10P、B1A24S15P、B2A24S15P、B2A24S20P product appearance is shown in Figure 3.

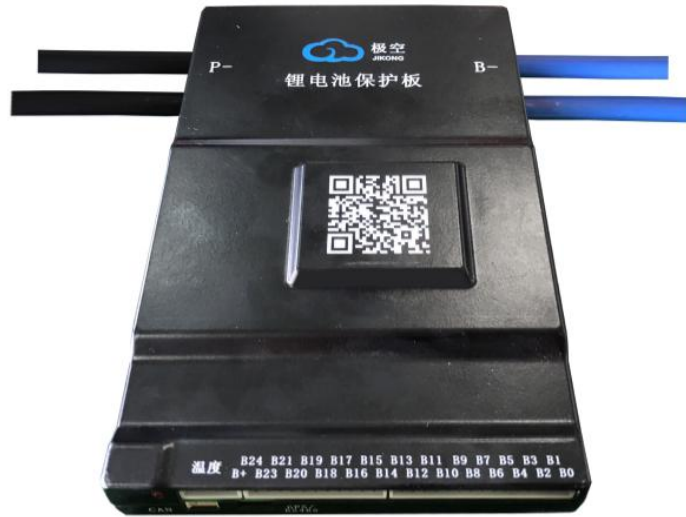

Figure 3. BD6A20S10P/B2A24S10P/ B1A24S15P/B2A24S15P/B2A24S20P Product Display

BD6A17S6P、BD6A20S6P product appearance is shown in Figure 4.



Figure 4. BD6A17S6P/BD6A20S6P Product Display

3.4 Size

The size of BD6A20S10P、B2A24S10P、B1A24S15P、B2A24S15P、B2A24S20P protection board is 162mm×102mm×20.4mm, and its dimensions are shown in Figure 5.

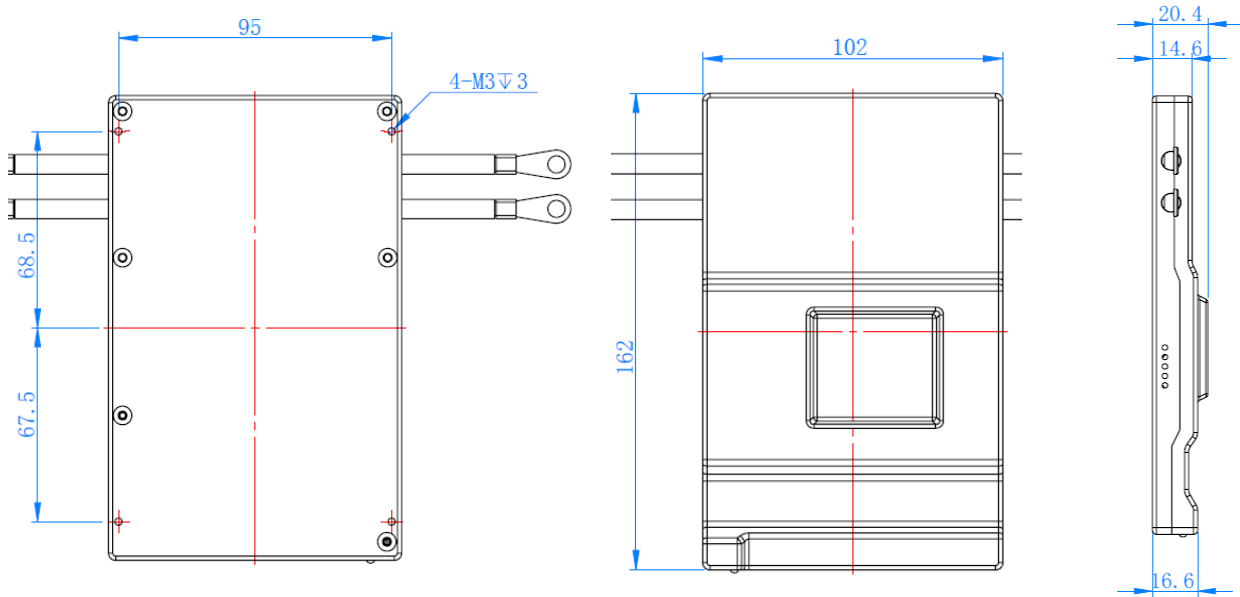

Figure 5. Outline Dimension Diagram of BD6A20S10P/B2A24S10P/
B1A24S15P/B2A24S15P/B2A24S20P

The size of BD6A17S6P、BD6A20S6P protection board is 115mm×78mm× 17.6mm, and the overall dimension is shown in Figure 6.

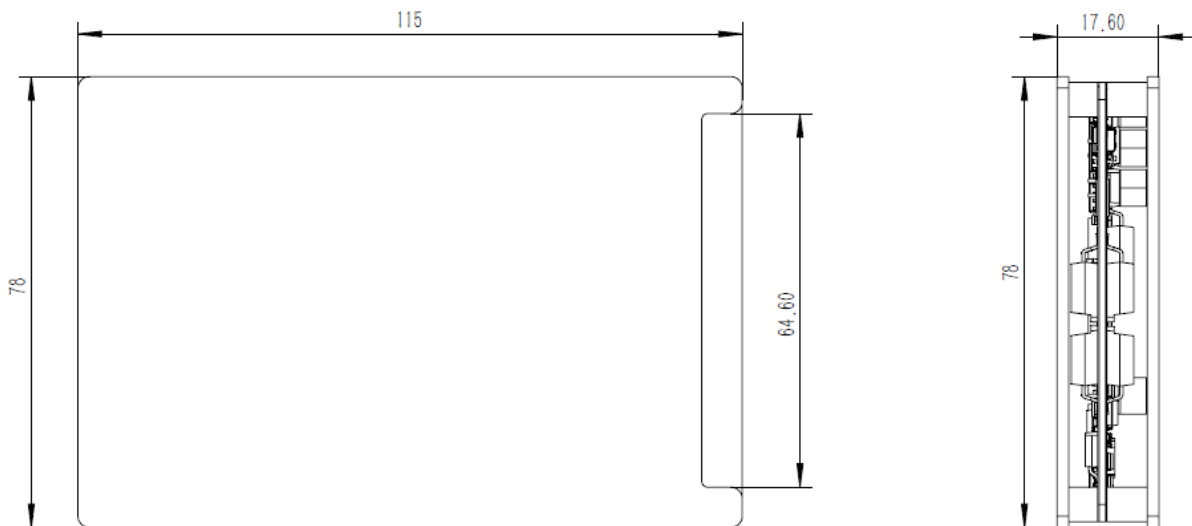

Figure 6. Outline Dimension Drawing of BD6A17S6P/BD6A20S6P

3.5 Weight

The weight of BD6A17S6P/BD6A20S6P protection board is about 370g.
The weight of BD6A20S10P/B2A24S10P/B1A24S15P/B2A24S15P/B2A24S20P protection board is about 210g.

4 Installation Methods and Precautions

4.1 Unpacking Inspection and Precautions

Unpacking inspection and precautions are as follows:

- a) The packing box and protection board shall be handled with care and not inverted as far as possible;
- b) Before unpacking, pay attention to whether the package is in good condition, such as whether there are impact marks, damage, etc;

4.2 Wiring Diagram

The BD6A20S10P、B2A24S10P、B1A24S15P、B2A24S15P、B2A24S20P intelligent lithium battery protection board is suitable for 13-24 series of lithium battery packs and the battery pack wiring method is different for different numbers of batteries.

For a battery pack with 24 strings in series, the installation and wiring method is shown in Figure 7.

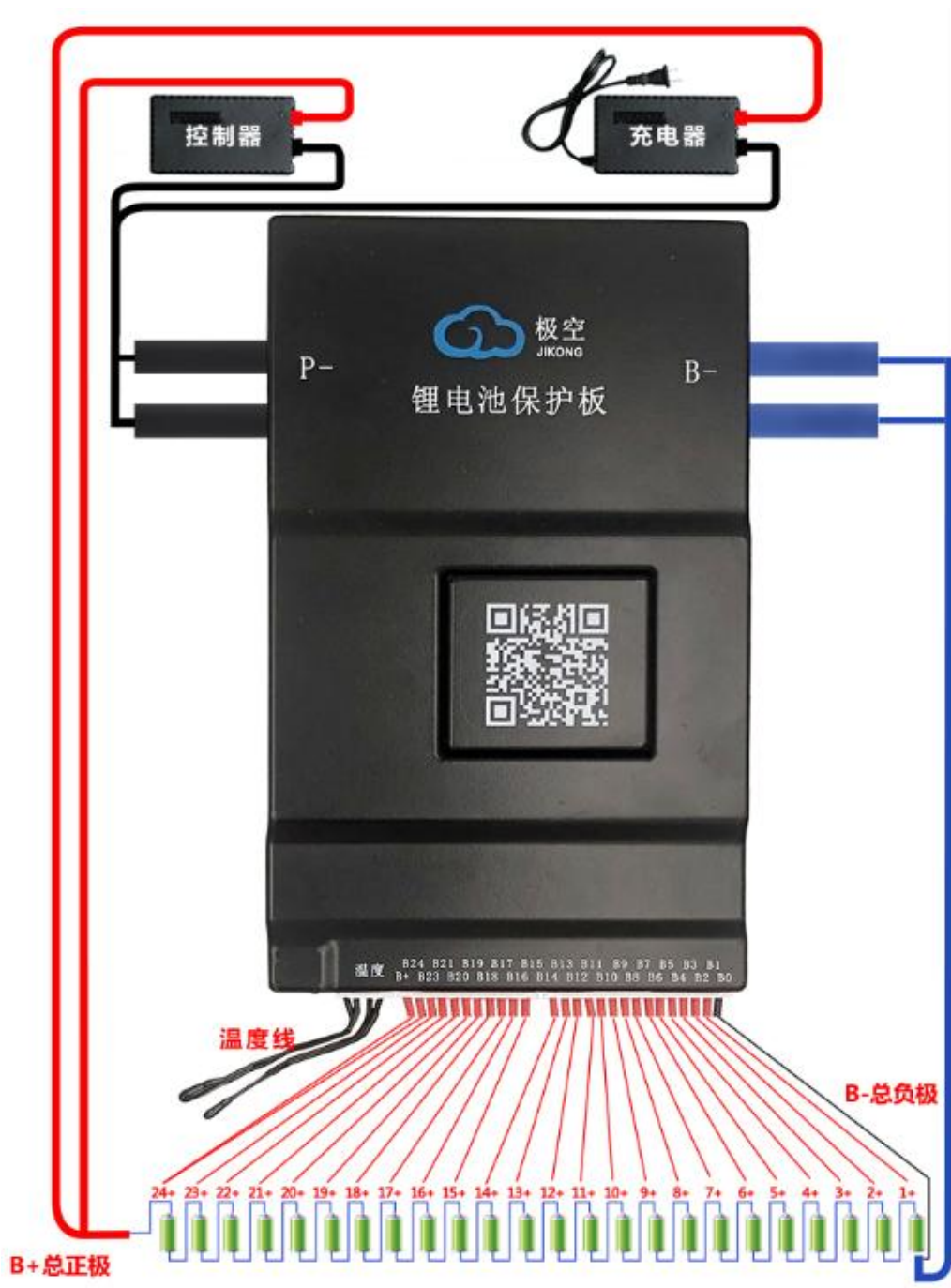

Figure 7. 24S Battery Wiring Diagram

For a battery pack with 23 strings in series, the installation and wiring method is shown in Figure8.

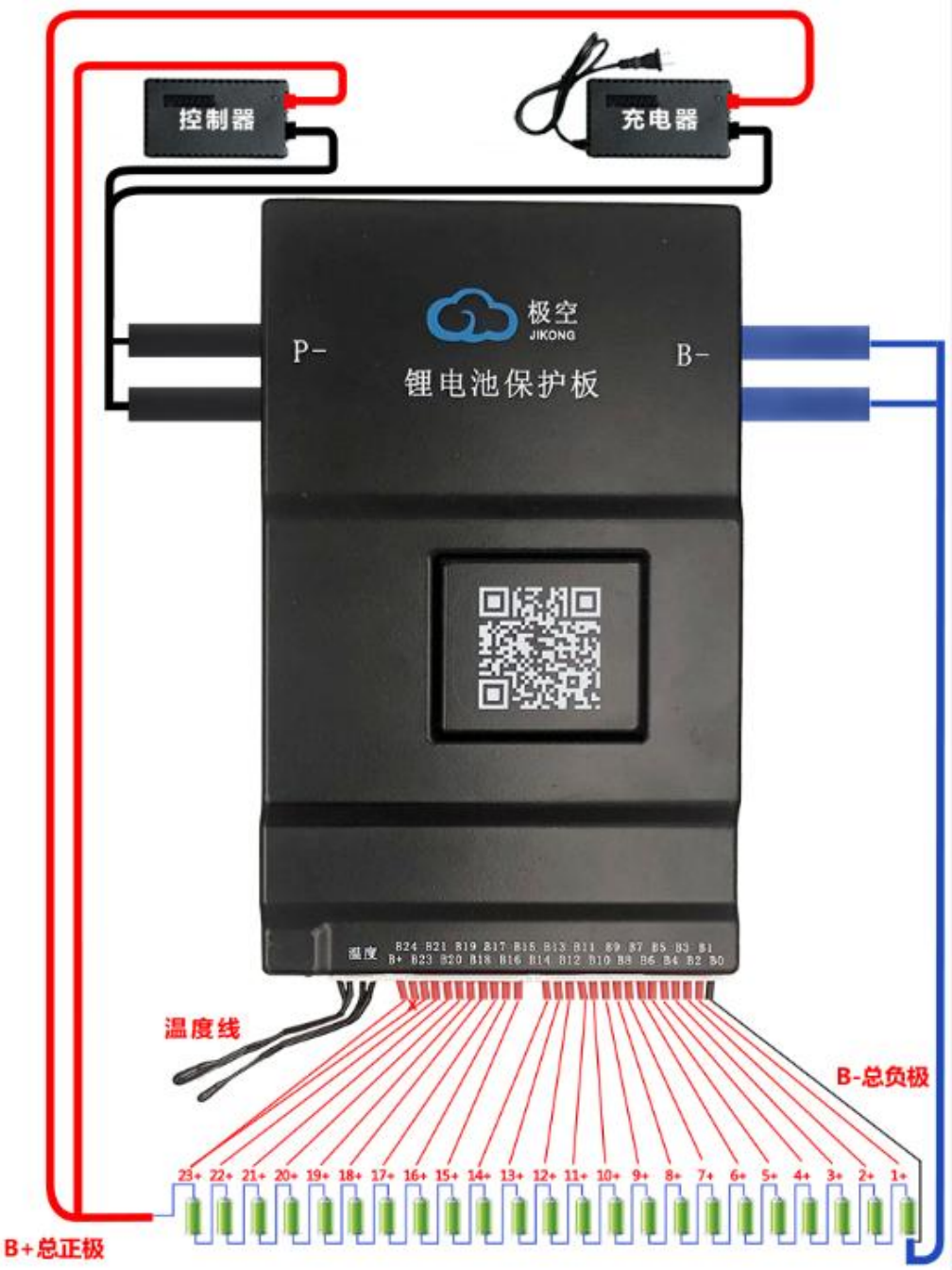

Figure 8. 23S Battery Wiring Diagram

For a battery pack with 22 strings in series, the installation and wiring method is shown in Figure 9.

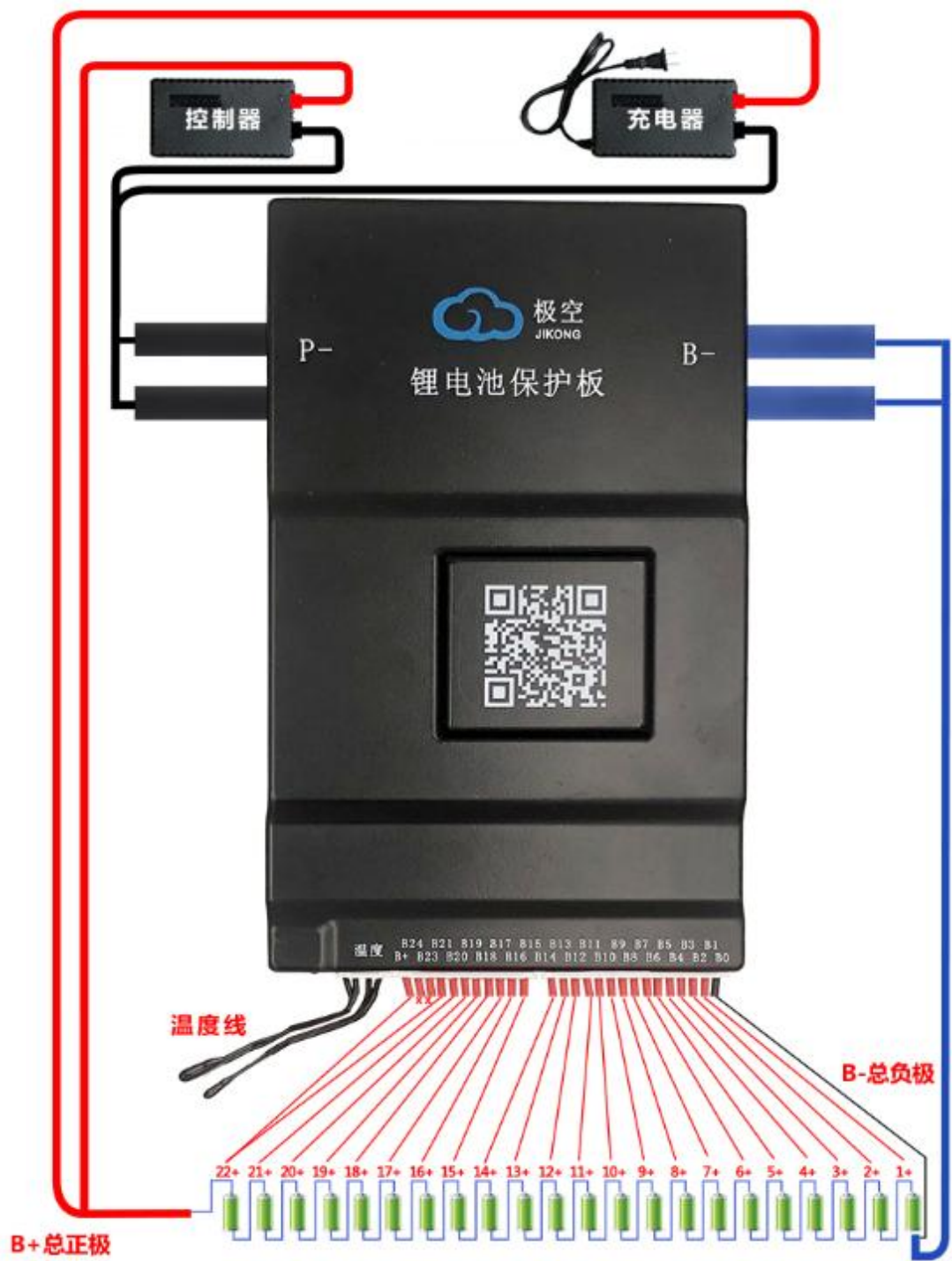

Figure 9. 22S Battery Wiring Diagram

For a battery pack with 21 strings in series, the installation and wiring method is shown in Figure 10.

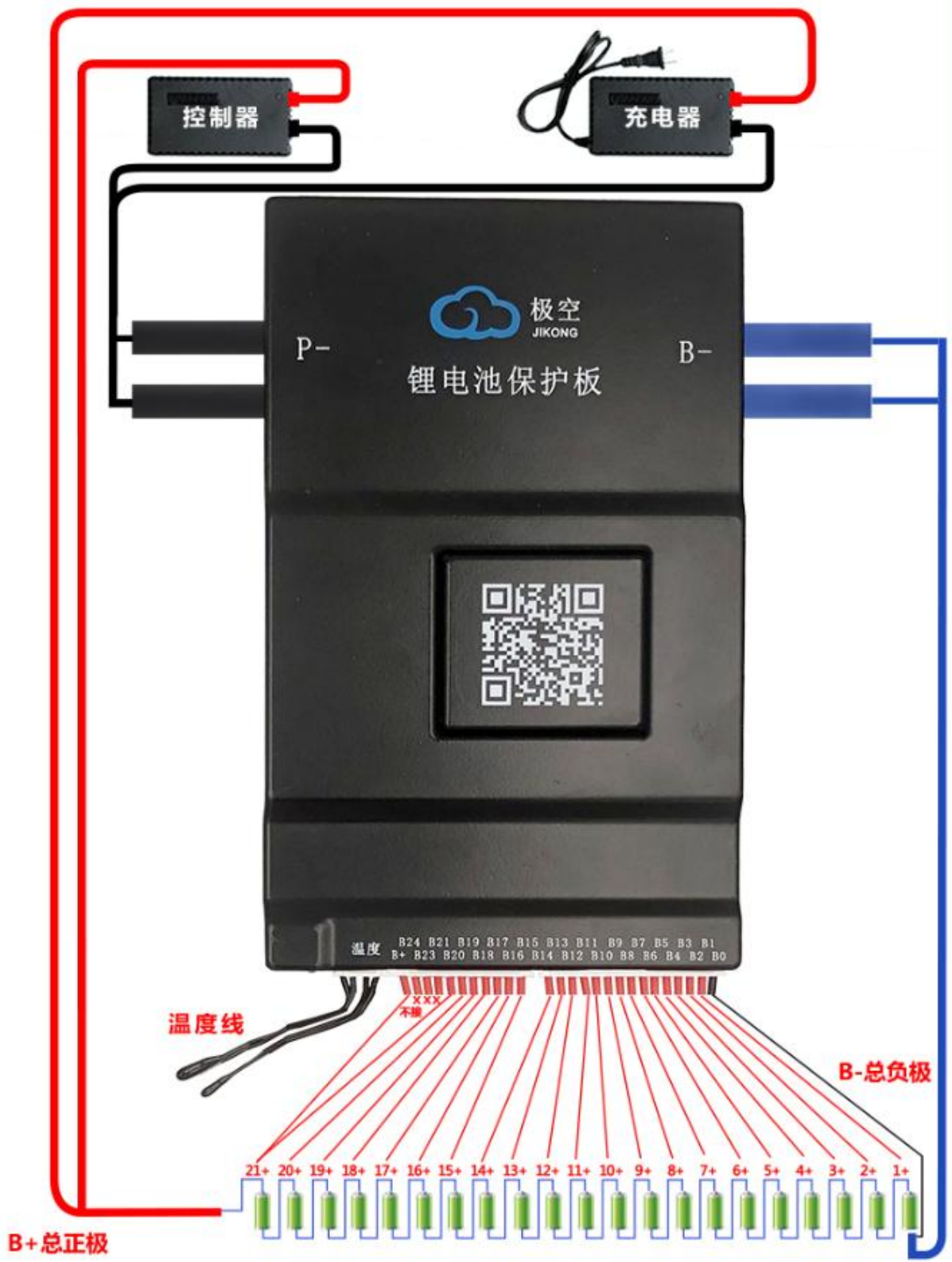

Figure 10. 21S Battery Wiring Diagram

For a battery pack with 20 strings in series, the installation and wiring method is shown in Figure 11.

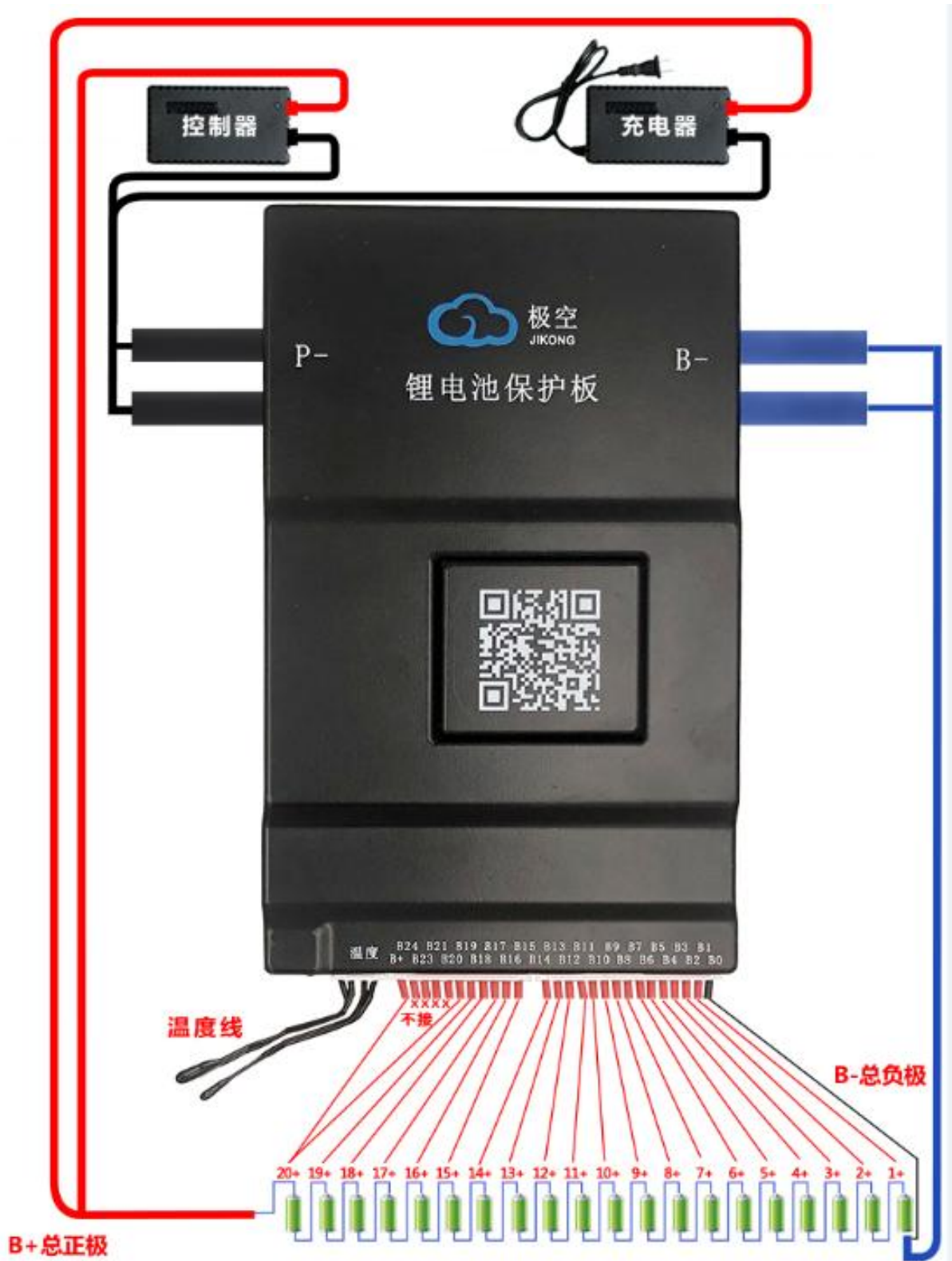

Figure 11. 20S Battery Wiring Diagram

For a battery pack with 19 strings in series, the installation and wiring method is shown in Figure 12.

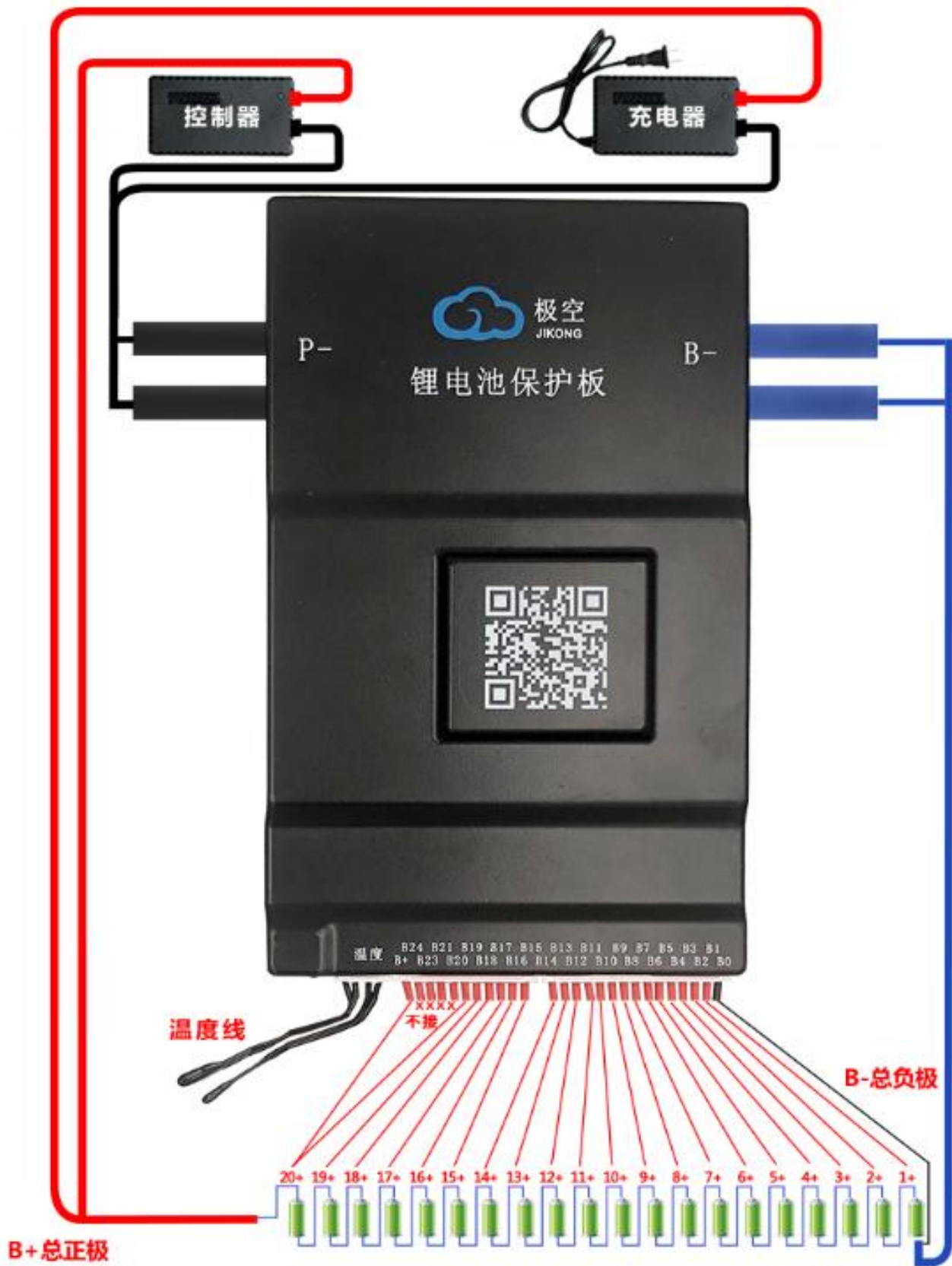

Figure 12. 19S Battery Wiring Diagram

For a battery pack with 18 strings in series, the installation and wiring method is shown in Figure 13.

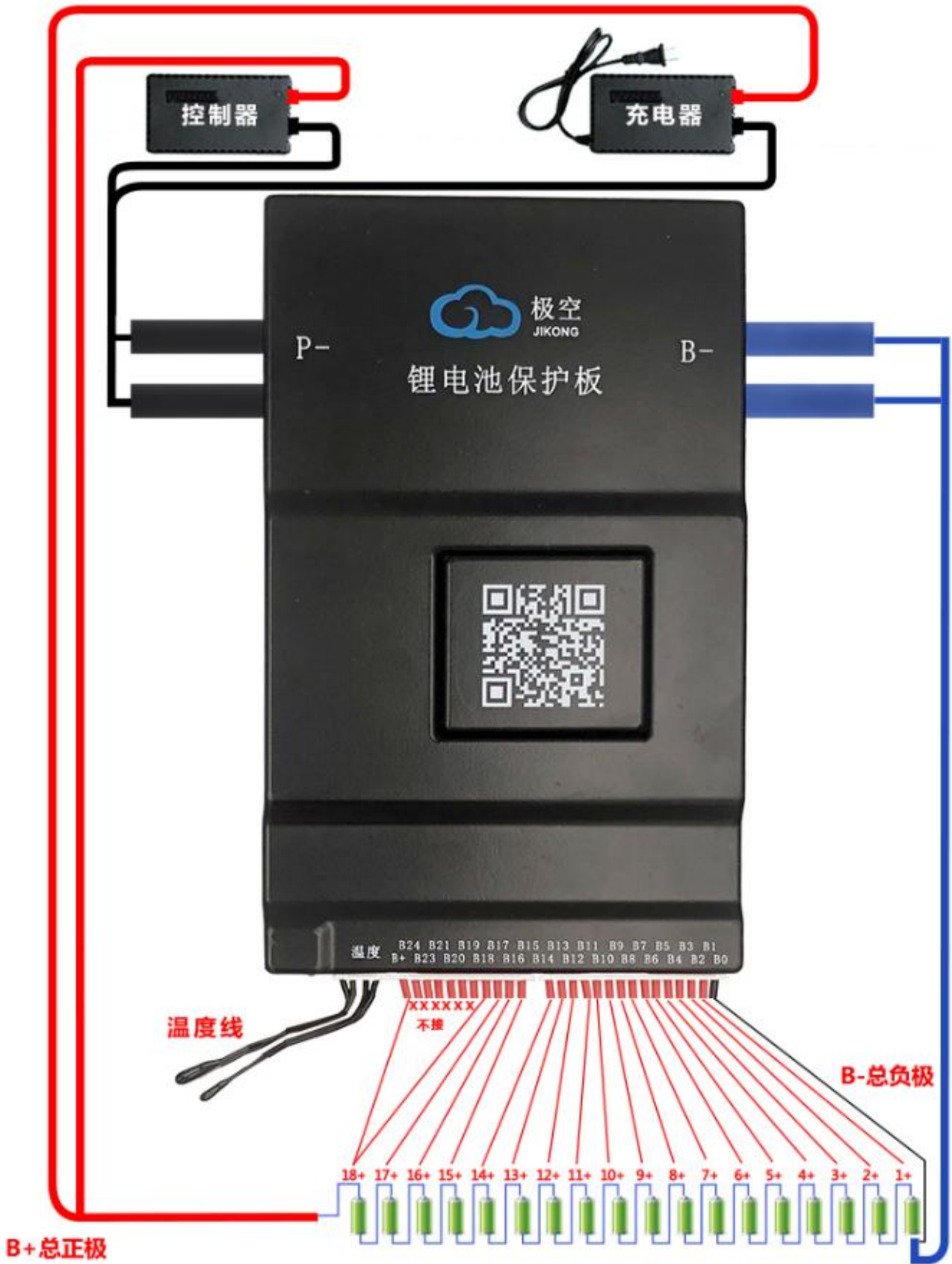

Figure 13. 18S Battery Wiring Diagram

For a battery pack with 17 strings in series, the installation and wiring method is shown in Figure 14.

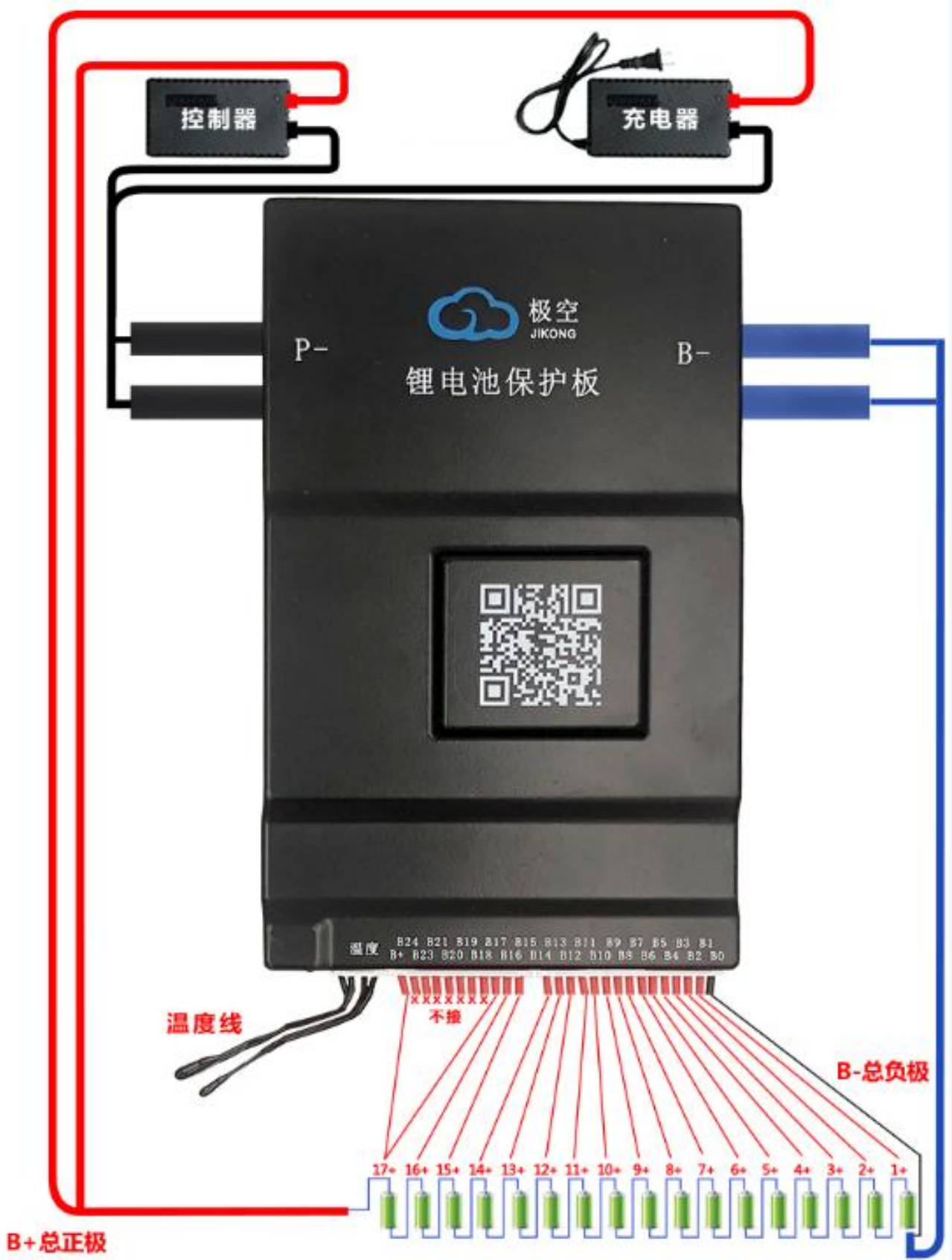

Figure 14. 17S Battery Wiring Diagram

For a battery pack with 16 strings in series, the installation and wiring method is shown in Figure 15.

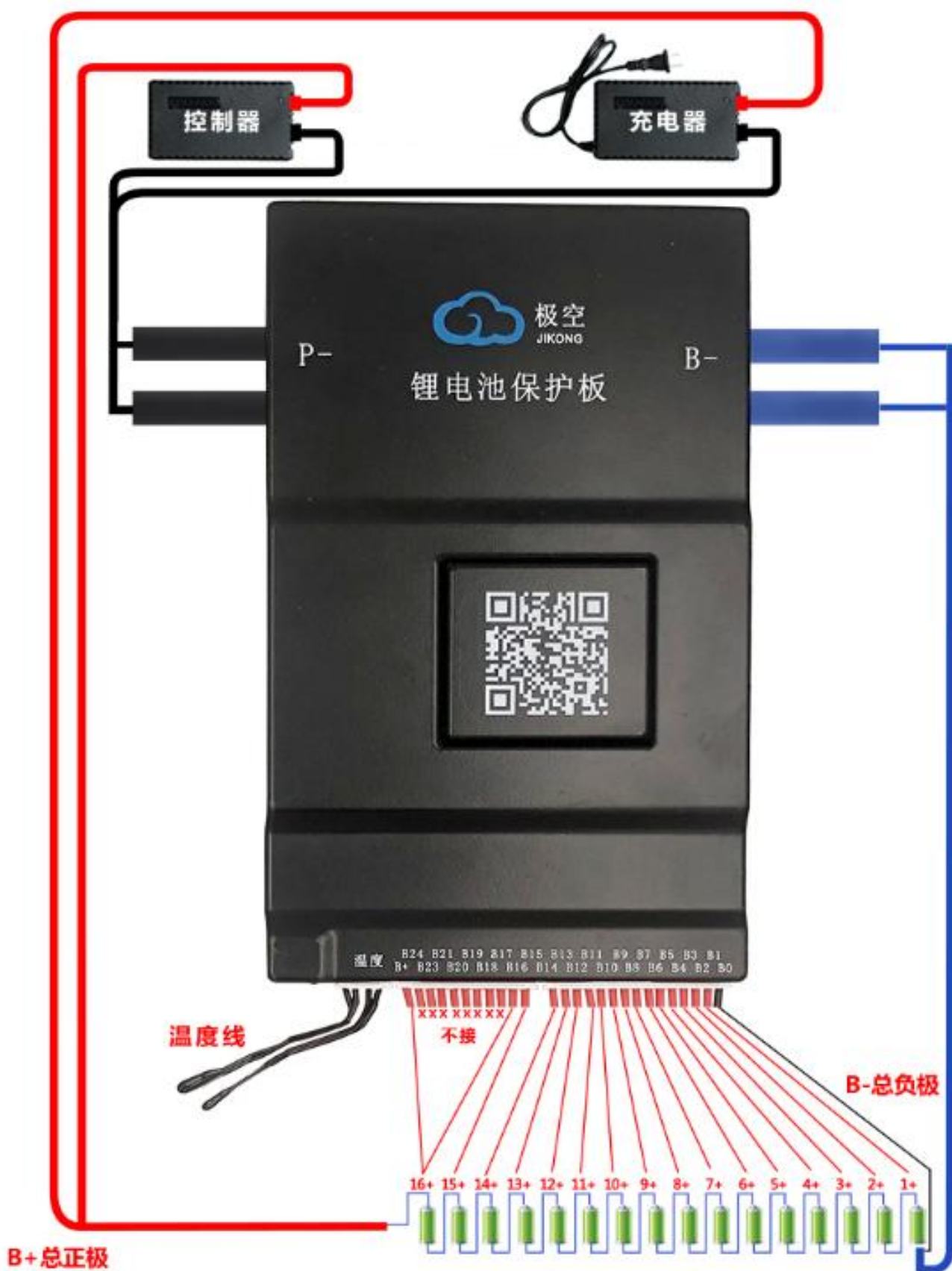

Figure 15. 16S Battery Wiring Diagram

For a battery pack with 15 strings in series, the installation and wiring method is shown in Figure 16.

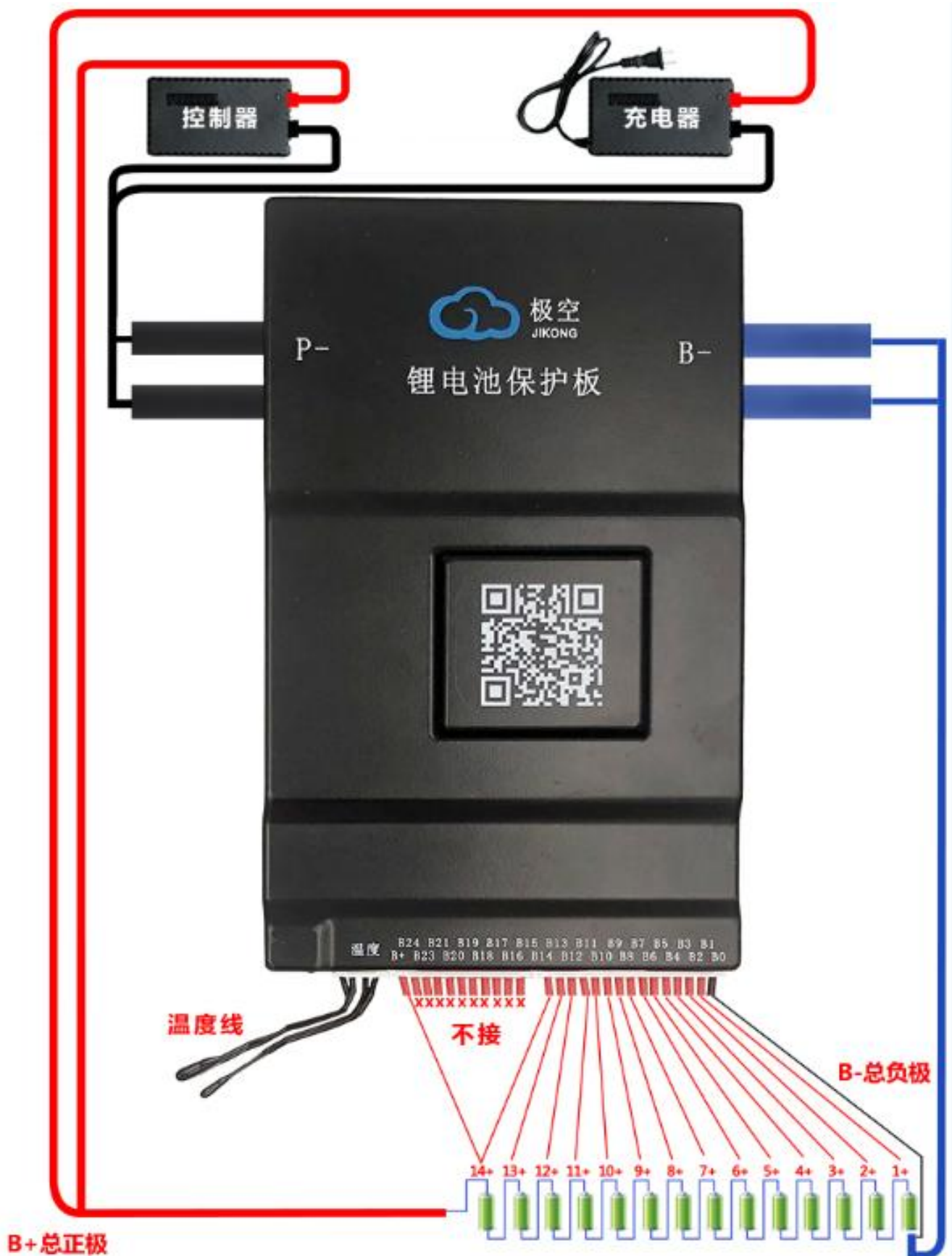

Figure 16. 15S Battery Wiring Diagram

For a battery pack with 14 strings in series, the installation and wiring method is shown in Figure 17.

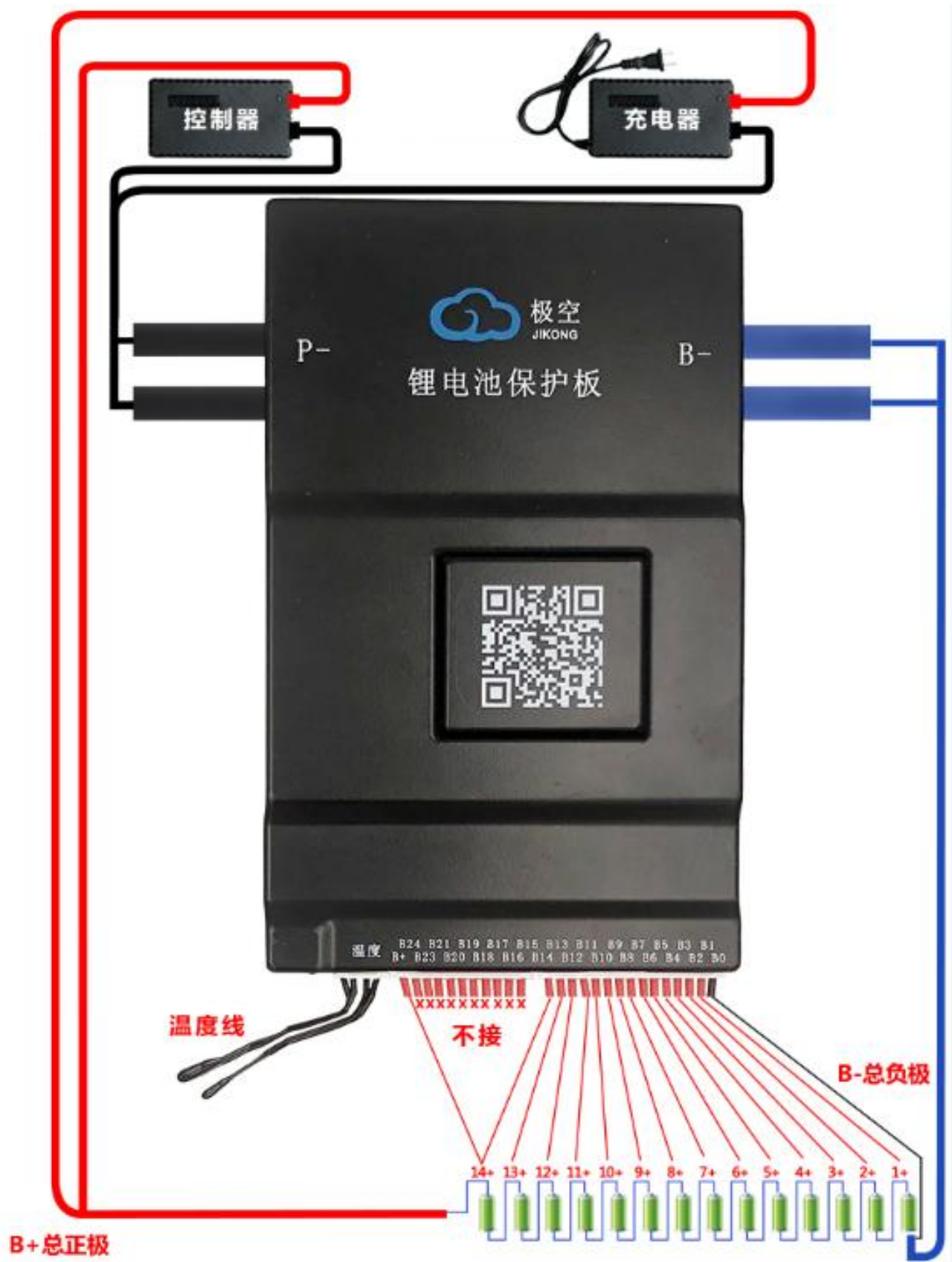

Figure 17. 14S Battery Wiring Diagram

For a battery pack with 13 strings in series, the installation and wiring method is shown in Figure 18.

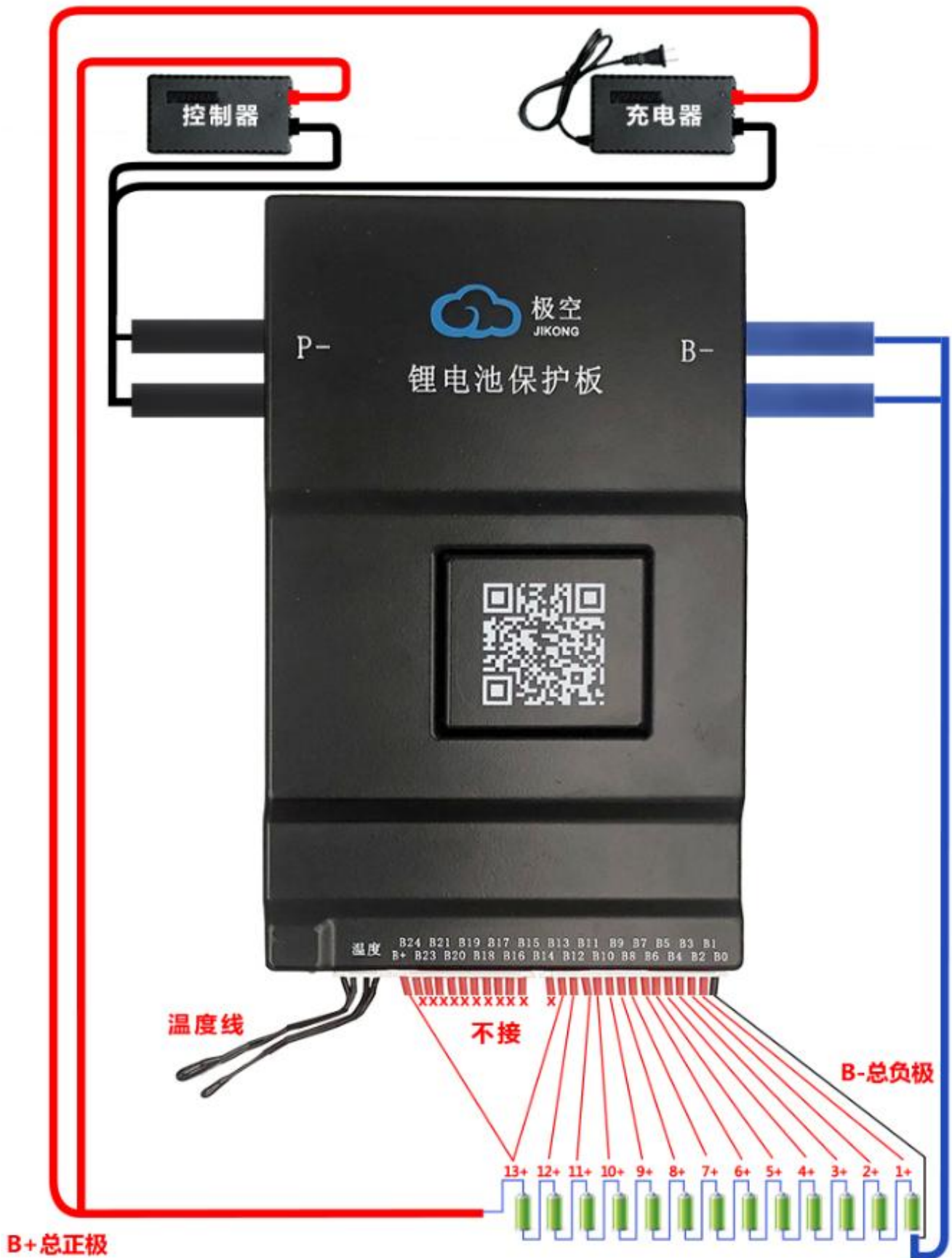

Figure 18. 13S Battery Wiring Diagram

The BD6A20S6P、BD6A17S6P intelligent lithium battery protection board is suitable for 13-20 series of lithium battery packs and the battery pack wiring method is different for different numbers of batteries.

For a battery pack with 20 strings in series, the installation and wiring method is shown in Figure

19.

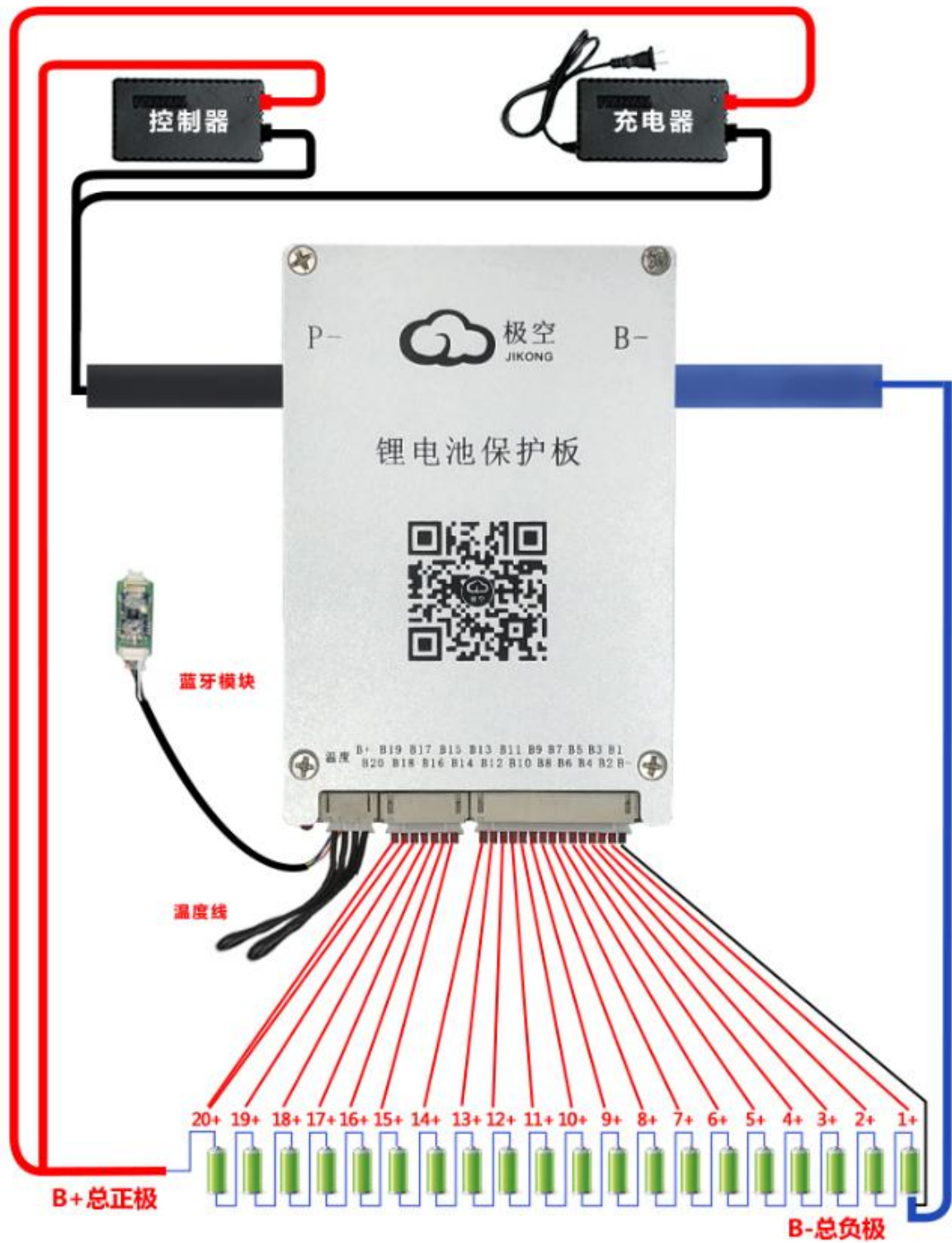

Figure 19. 20S Battery Wiring Diagram

For a battery pack with 19 strings in series, the installation and wiring method is shown in Figure 20.

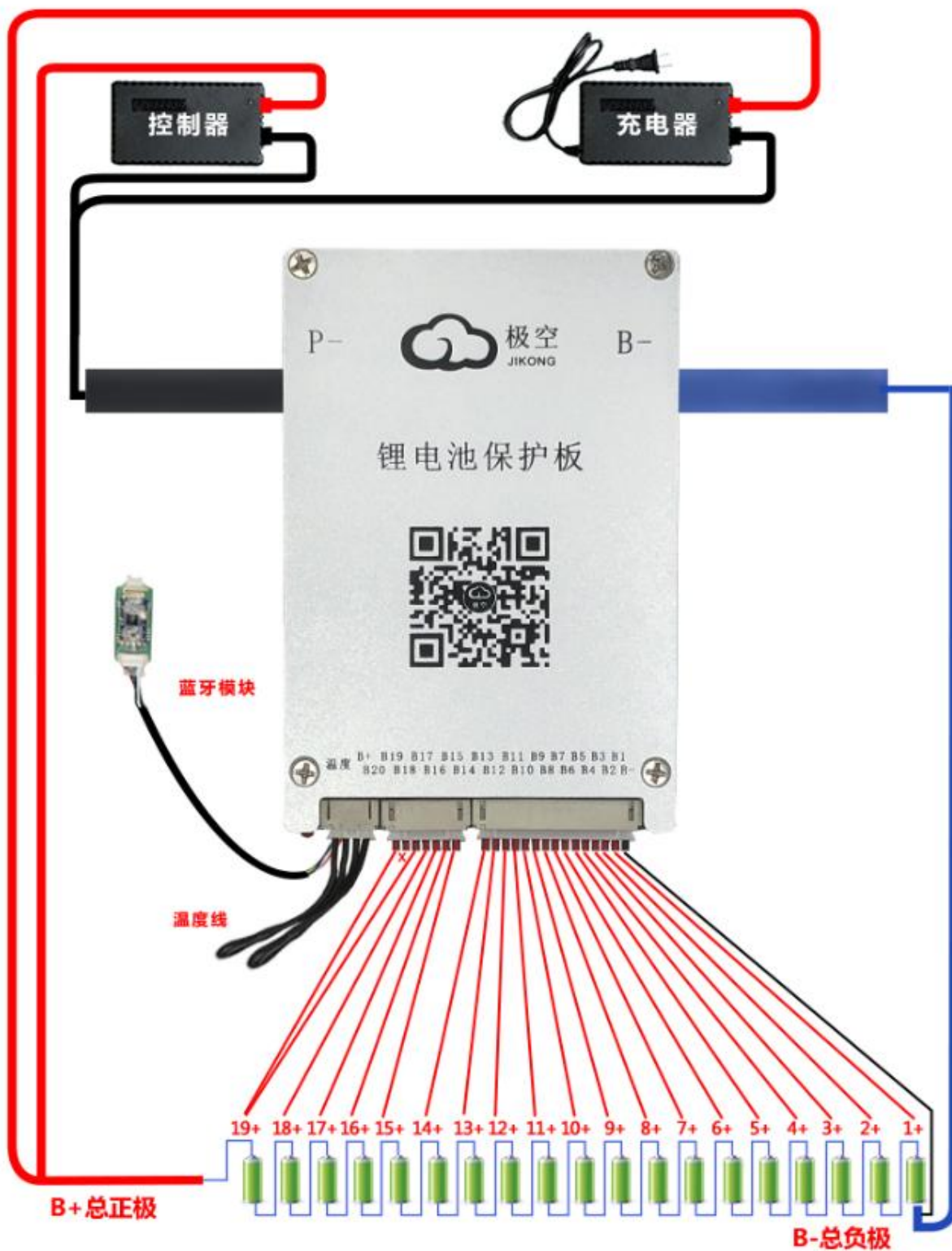

Figure 20. 19S Battery Wiring Diagram

For a battery pack with 19 strings in series, the installation and wiring method is shown in Figure 21.

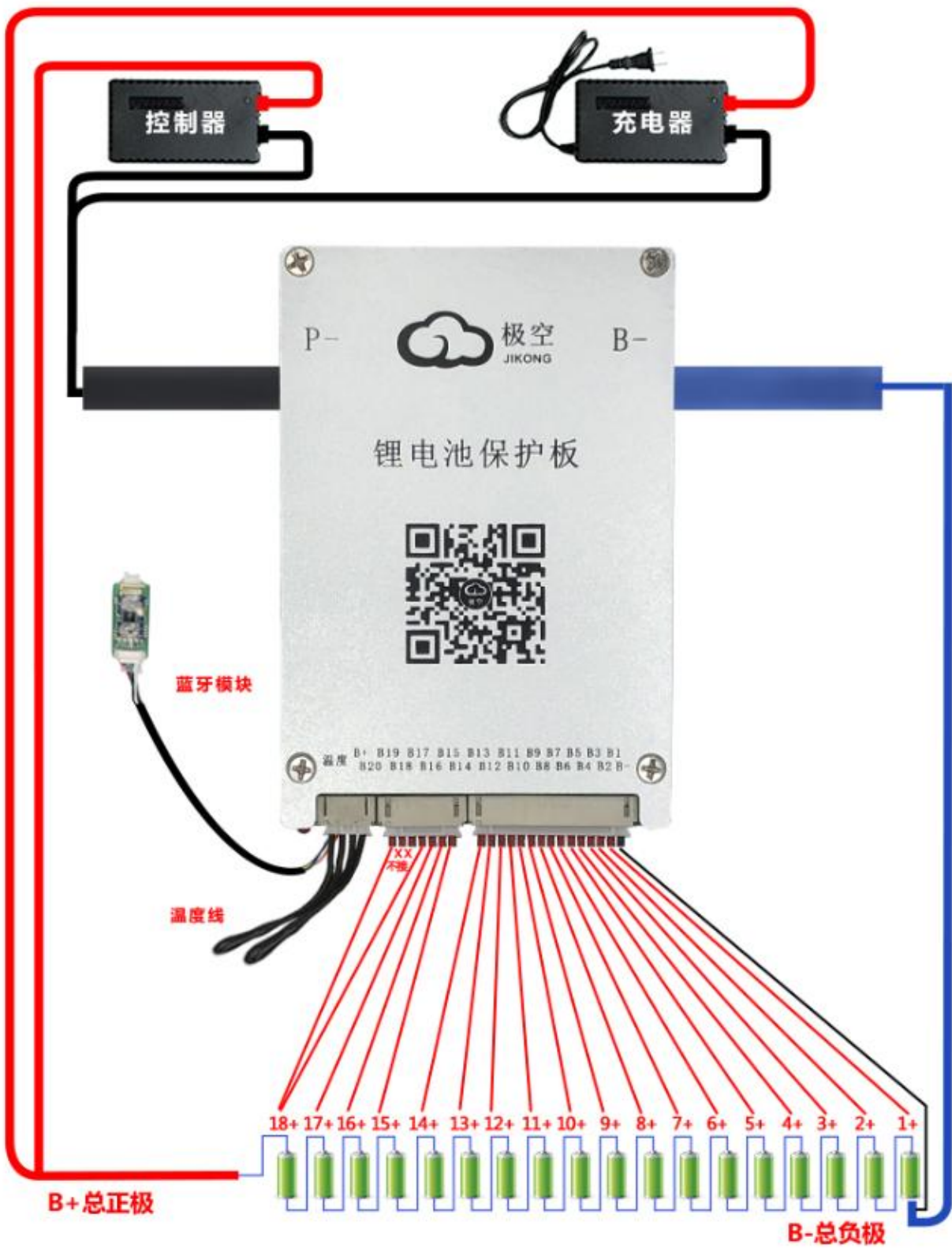

Figure 21. 18S Battery Wiring Diagram

For a battery pack with 17 strings in series, the installation and wiring method is shown in Figure 22.

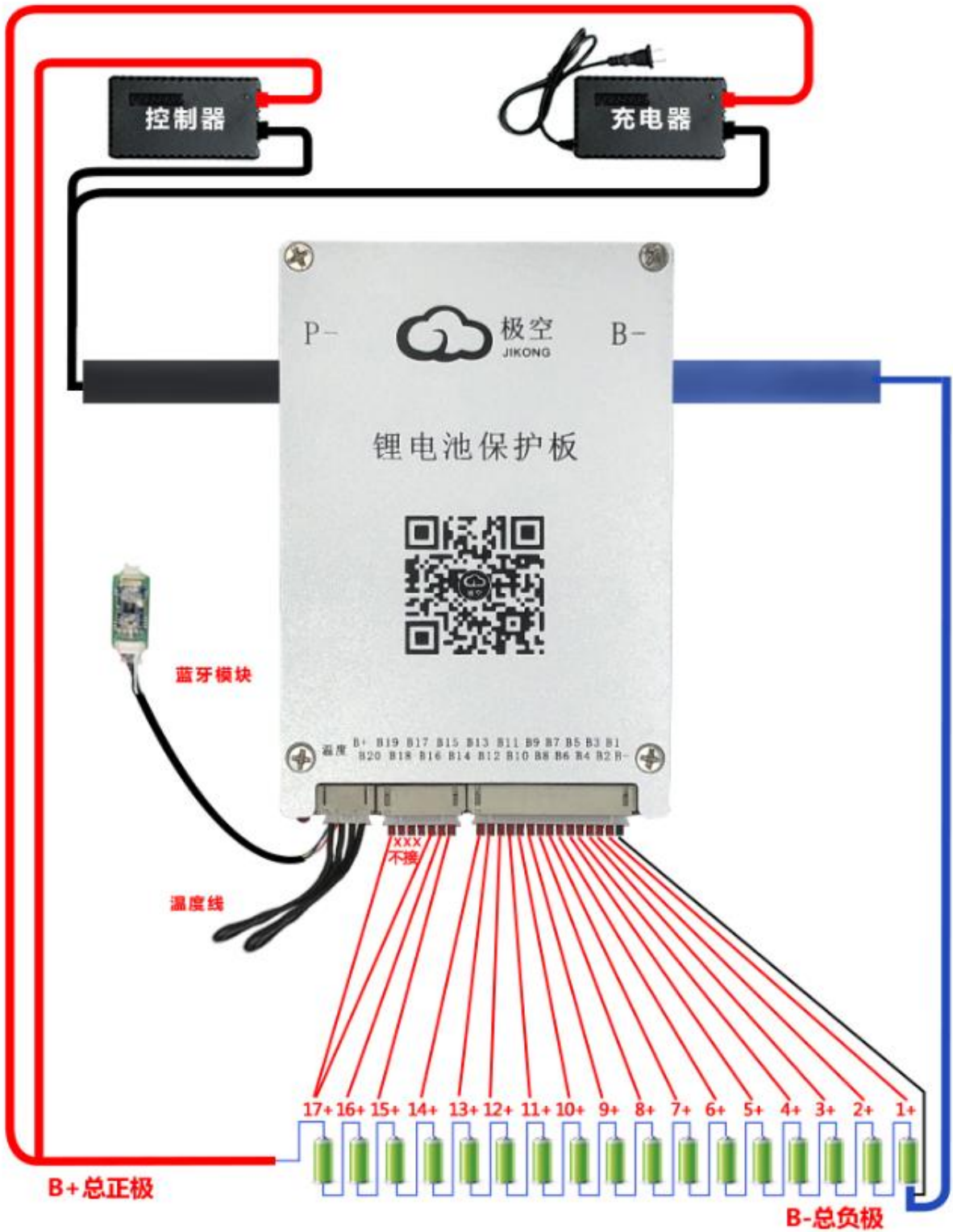

Figure 22. 17S Battery Wiring Diagram

For a battery pack with 16 strings in series, the installation and wiring method is shown in Figure 23.

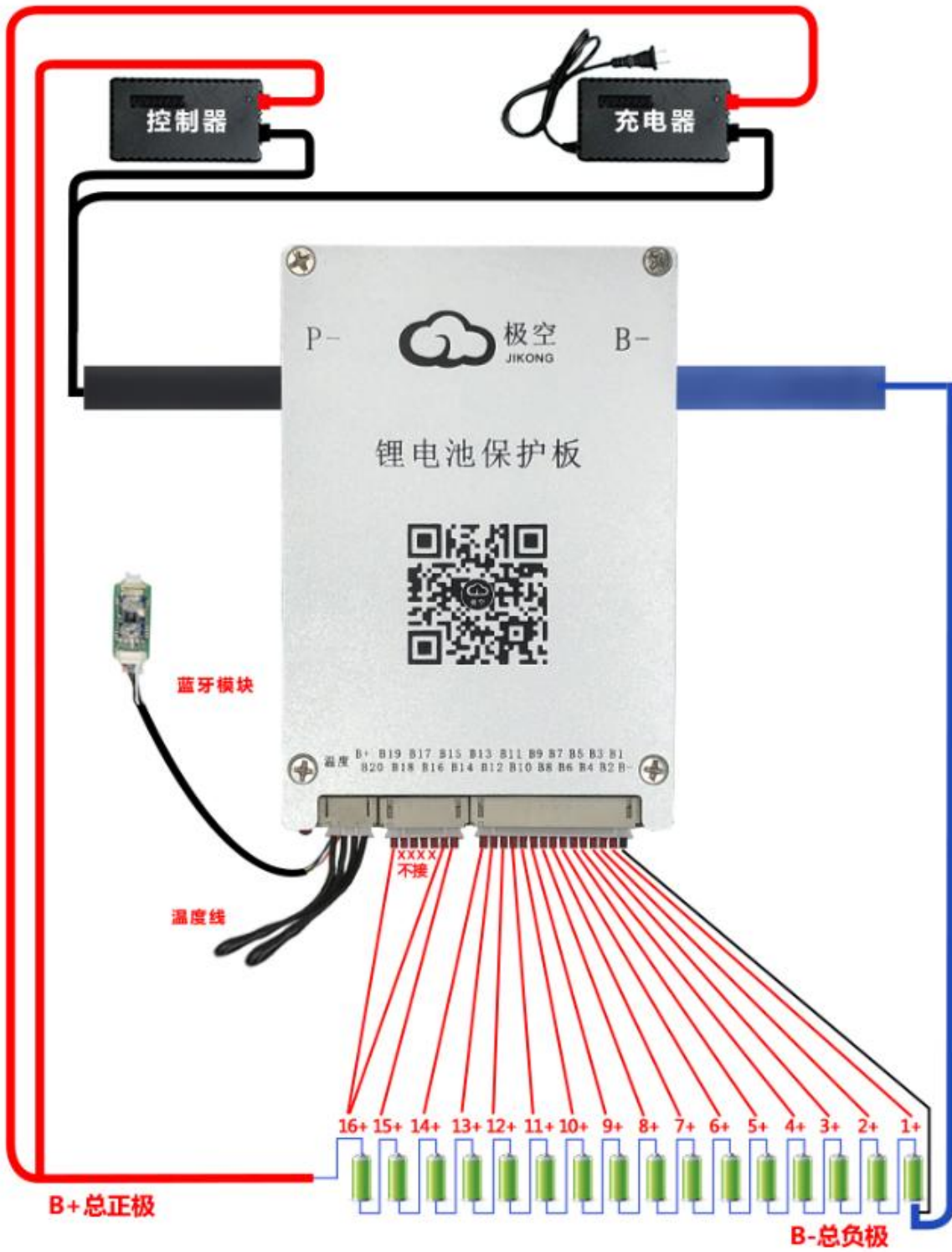

Figure 23. 16S Battery Wiring Diagram

For a battery pack with 15 strings in series, the installation and wiring method is shown in Figure 24.

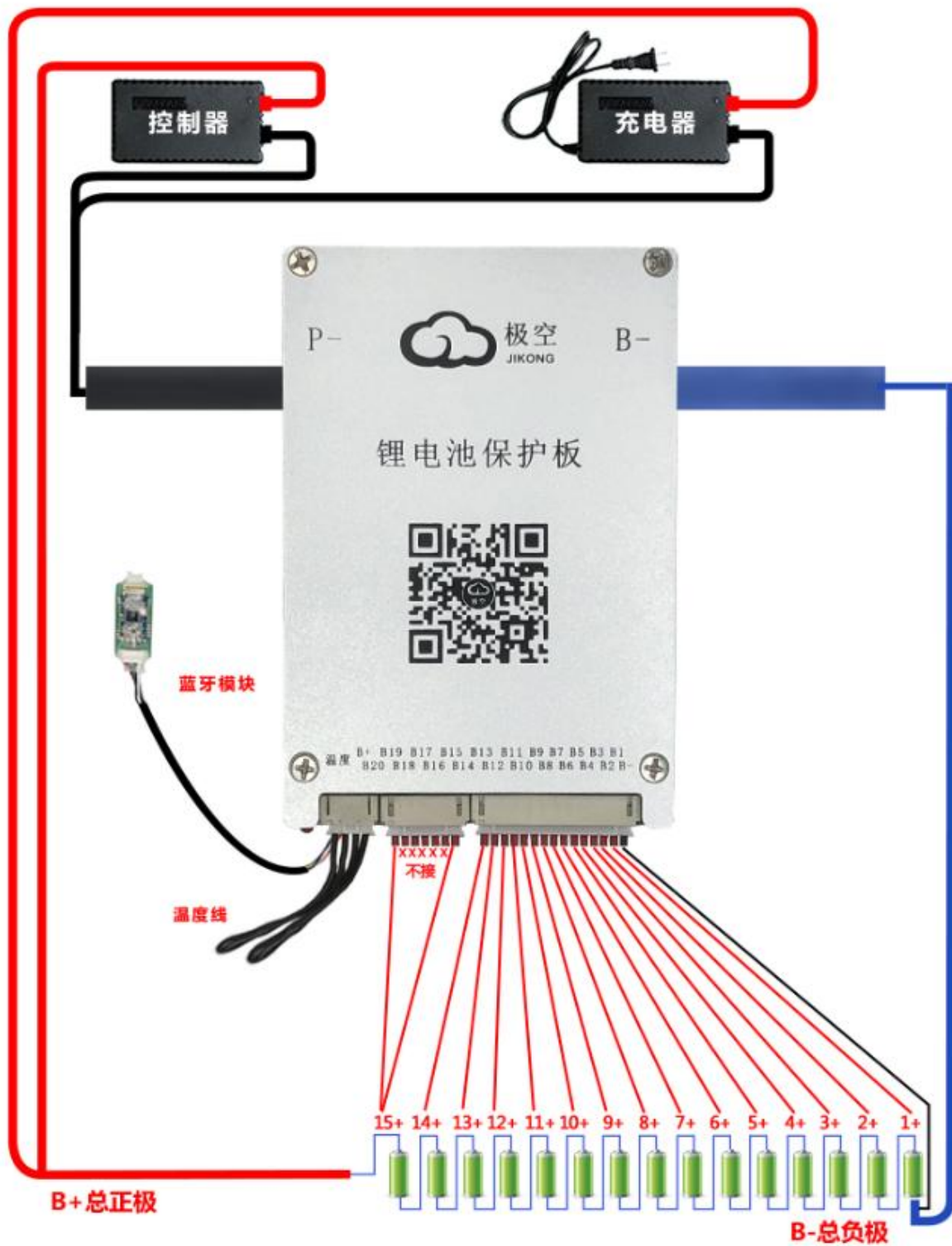

Figure 24. 15S Battery Wiring Diagram

For a battery pack with 14 strings in series, the installation and wiring method is shown in Figure 25.

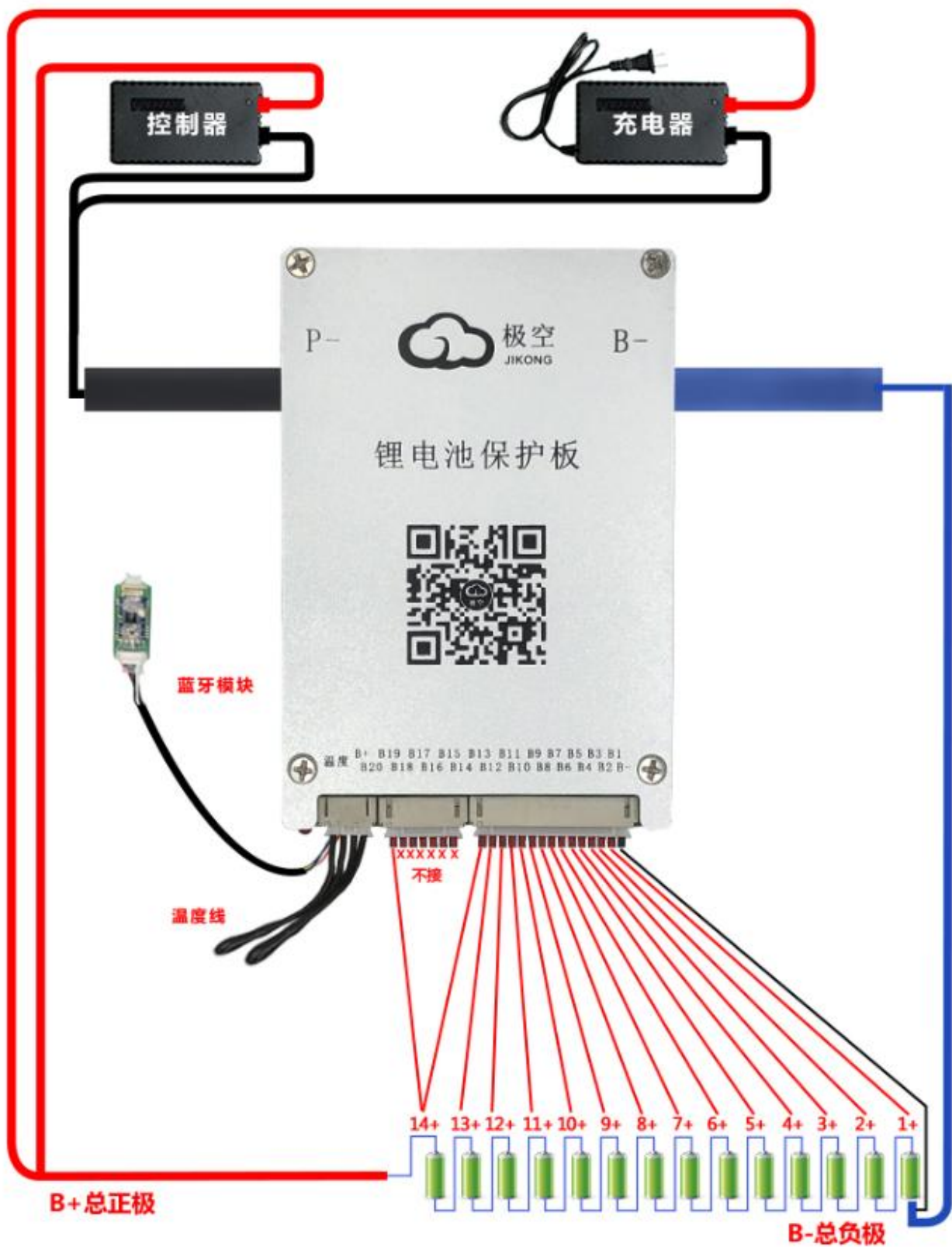

Figure 25. 14S Battery Wiring Diagram

For a battery pack with 13 strings in series, the installation and wiring method is shown in Figure 26.

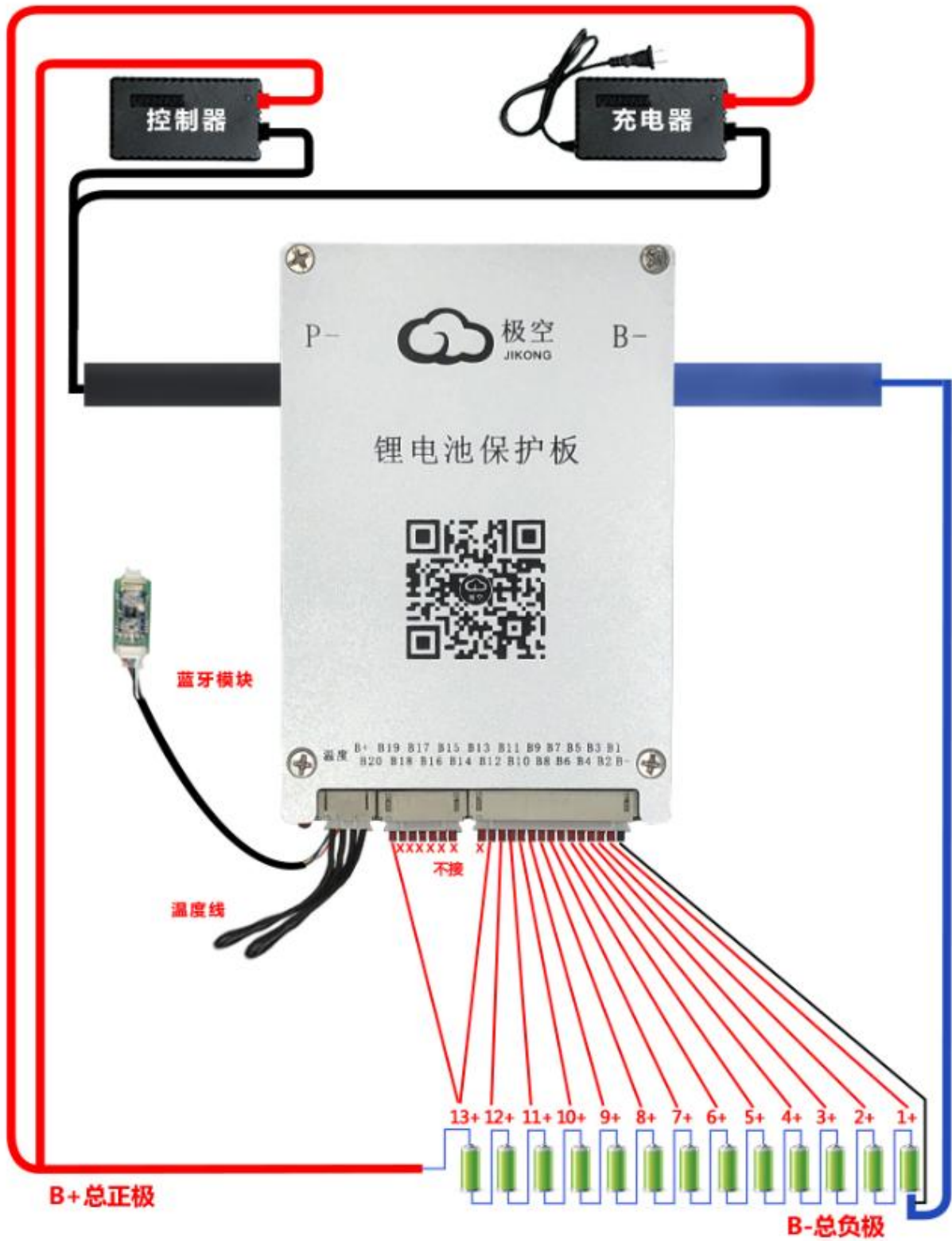

Figure 26. 13S Battery Wiring Diagram

4.3 App installation

By scanning the QR code shown in Figure 27, you can obtain the mobile app that matches the product



Figure 27 QR code of mobile app link

5 Use and operation

5.1 Preparation and inspection before use

Before turning on the protection board, please confirm whether the balance line is connected normally and whether "C-" and "B-" are connected correctly. Check whether the protection board is securely fixed to the battery core, and then you can switch on the protection board after confirming that it is correct. Otherwise, it may cause serious consequences such as abnormal operation and even burnout.

5.2 Power on of protection board

After confirming that the above operations are correct, you can power on the protection board. The protection board does not have a power-on control switch, and is designed to be in a charging activation mode. **(meet the condition: the voltage of the charger is 5V higher than that of the battery)** That is, after the battery is assembled, a charger needs to be connected to start the protection board.

5.3 App operating instructions

5.3.1 Equipment operation

a) Equipment connection

First turn on the mobile phone's Bluetooth, and then open the APP, as shown in Figure 28.

Click the icon in the upper left corner to scan the device. After the scan is completed, **click the name of the device to be connected**, such as "JK-B1A24S". The APP will prompt for a password when connecting for the first time. The default password of the device is "1234". The APP will automatically record the password after the device is connected. There is no need to

enter the password for the next connection. It will automatically connect after starting the APP, The password input interface is shown in Figure 29.

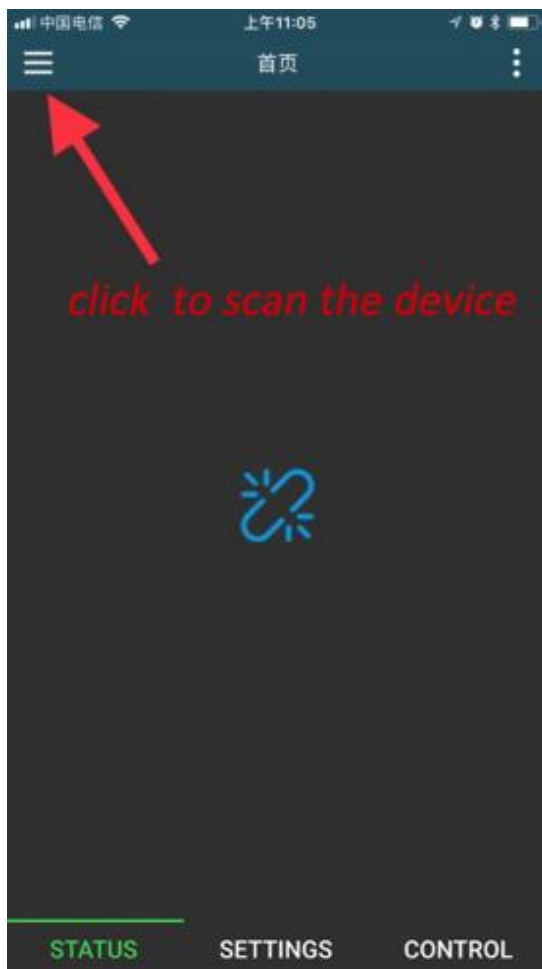

Figure 28. Device Scan

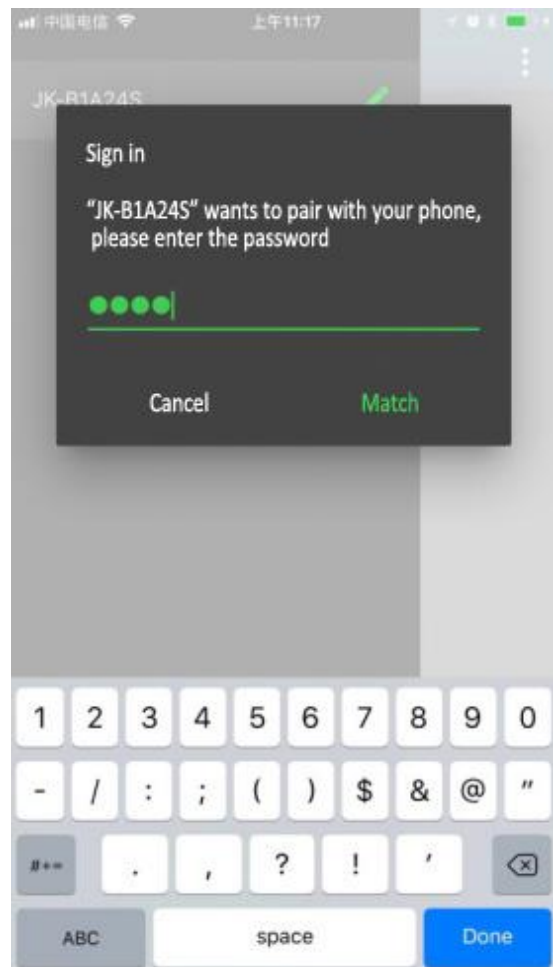

Figure 29. Password Input

b) Change name and password

After the device is connected, click the "pen type" icon on the right side of the device list to modify the device name and password.

The interface for modifying the device name is shown in Figure 30. Note that the device name only supports English or numbers.

The password change interface is shown in Figure 31. To change the device password, you must first enter the old password of the device. Only when the current password is correct can you enter the new password entry option. After entering the new password twice, click 'OK' to complete the device password modification.



Figure 30 Name Modification



Figure 31 Password Modification

5.3.2 Status View

The real-time status interface is shown in Figure 32.



1 Battery comprehensive information column

2 Cells voltage
The voltage data of each cell in the battery pack is displayed in real time, in which red represents the cell with the lowest voltage and blue represents the cell with the highest voltage.

3 Cell wire resistance
The equalizing line resistance is the equalizing line resistance obtained by the self inspection of the protection board. The value is only a preliminary calculation to prevent wrong connection or poor contact. When the equalizing line resistance exceeds a certain value, it will be displayed in yellow, and the equalizing cannot be turned on at this time.

Figure 32 The Real-time Status

The real-time status page is divided into 3 areas.

Area 1 in the figure is battery comprehensive information column. The parameters are defined as follows:

a) Time

The time indicates the total running time from the time the protection board is turned on until now.

b) Charging

Indicates the opening status of the current protection board charging MOS. When "on" is displayed, it means that the current protection board charging MOS is on and the battery is allowed to charge; when "off" is displayed, it means that the current protection board charging MOS is off and the battery is not allowed to charge.

c) Discharge

Indicates the open status of the current protection board discharge MOS. When "on" is displayed, it means that the current protection board discharge MOS is on and the battery is allowed to discharge; when "off" is displayed, it means that the current protection board discharge MOS is off and the battery is not allowed to discharge.

d) Balance

Indicates the on / off status of the protection board. When "On" is displayed, the protection board will automatically balance after the balance starting conditions are met; when "Off" is displayed, it means that the balance is off, and the protection board will not balance the battery.

e) Voltage

The voltage area displays the current total voltage of the battery in real time, and the total voltage is the sum of all unit voltages.

f) Current

The current area displays the total current of the current battery in real time. When the battery is charging, the current is positive, and when the battery is discharging, the current is negative.

g) Battery Power

Represents the total power of the current battery output or input. Its value is the product of the current battery voltage and the absolute value of the battery current.

h) Remain Battery

Represents the percentage of current battery power remaining.

i) Battery Capacity

Represents the actual battery capacity calculated by the current protection board based on the high-precision SOC. The unit is AH. **(The value needs to be updated after the battery has completed a full discharge and charge cycle)**

j) Remain Capacity

Remaining capacity indicates the remaining capacity of the current battery, unit: AH.

k) Cycle Capacity

The cycle capacity indicates the cumulative discharge capacity of the battery, and the unit is AH.

l) Cycle Count

The Cycle Count indicates the number of charge saturation times of the current battery, the unit is: times.

m) Ave. Cell Vol.

The average cell voltage of the current battery, unit: V.

n) Delta Cell Vol.

The Delta Cell Vol. represents the difference between the highest battery voltage and the lowest battery voltage of the entire battery pack. The unit is V.

o) Balance Cur.

When the protection board turns on the balance function and reaches the balance condition, it displays the balance current in real time. Unit: A.

When the balance is performed, the status display area of the real-time status, blue represents a discharged battery, and red represents a charged battery.

When balance is in progress, the status display area of the real-time status, blue represents the discharged battery, and red represents the charged battery. The negative current of balance current indicates that the battery is discharging. At this time, the blue flashes. The positive current of balance current indicates that the battery is charging. At this time, the red flashes.

Active balance technology is used in the protection board. The principle of balance is to take power from the high-voltage core, store it in the protection board, and then put it into the low-voltage core.

p) MOS Temp

Real time display of the temperature of current protection board power MOS, unit: °C.

q) Battery T1

Display "Na" when the temperature sensor 1 is not installed, and display the temperature of the temperature sensor 1 in real time when the temperature sensor is installed, unit: °C.

r) Battery T2

Display "NA" when the temperature sensor 2 is not installed, and display the temperature of the temperature sensor 2 in real time when the temperature sensor is installed, unit: °C.

In the figure, area 2 is the voltage area of single body. The voltage data of each cell in the battery pack is displayed in real time, in which red represents the cell with the lowest voltage and blue

represents the cell with the highest voltage.

Area 3 in the figure is the area of cells wire resistance. The cells wire resistance is obtained by the self inspection of the protection board. The value is only a preliminary calculation to prevent wrong connection or poor contact. When the cells wire resistance exceeds a certain value, it will be displayed in yellow, and the balance cannot be turned on at this time.

5.3.3 Parameter Setting

The parameter setting page is shown in Figure 33.



Figure 33 Parameters Setting

In the parameter setting page, you can modify the working parameters of the protection board. The definitions of each parameter are as follows.

a) LIFEP04

This function button can modify all the working parameters of the protection board into the

parameters of the iron-lithium battery. For the default values of the parameters, see Appendix I.

b) LI-ION

This function button can modify all the working parameters of the protection board into the parameters of the iron-lithium battery. For the default values of the parameters, see Appendix II.

c) Cells Count

The cells count represents the number of cells in the current battery. Before use, please set this value accurately, otherwise the protection board will not work properly.

d) Battery Capacity

This value is the design capacity of the battery.

e) Trigger Diff Volt

Triggered balance difference Voltage is the only parameter that controls balance. When the balance switch is on, when the maximum difference voltage of the battery pack exceeds this value, the balance starts, and the balance ends when the difference voltage is lower than this value. For example, the balance trigger voltage difference is set to 0.01V. When the battery pack voltage difference is greater than 0.01V, balance is started, and when the battery pack voltage difference is lower than 0.01V, the balance is ended. (It is recommended that the balance trigger difference voltage of the battery above 50AH is 0.005V, and the balance trigger difference voltage of the battery below 50AH is 0.01V)

f) Voltage Calibration

The voltage calibration function can be used to calibrate the accuracy of the equalizer voltage acquisition.

When there is an error between the total voltage collected by the protection board and the total voltage of the battery, you can use the voltage calibration function to calibrate the protection board. The calibration method is to fill in the total battery voltage that is currently measured, and then click "Small Plane" behind the voltage calibration to complete the calibration.

g) "Cell UVP" and "Cell UVPR"

"Cell Low-voltage Protection" refers to the cut-off voltage of the battery cell. As long as the voltage of any cell in the battery pack is lower than this value, the "Cell Low-voltage Alarm" will be generated. At the same time, the protection board will be turned off to discharge MOS, at this time, the battery can not discharge, but can only charge. When the alarm occurs, only after the voltage of all the cells exceeds the value of "Cell Voltage Recovery" the protection board releases the "Cell Low-voltage Alarm" and turns on the discharge MOS at the same time.

h) "Cell OVP", "Cell OVPR"

"Cell OVP" refers to the saturation voltage of the cell. As long as the voltage of any single cell in the battery pack exceeds this value, a "single overcharge alarm" will be generated. At the same time, the protection board will turn off the MOS for charging. At this time, the battery cannot be charged and can only be discharged. After the alarm is generated, only when the voltage value of all cell is lower than the value of "Cell OVPR", the protection board will release the "cell overcharge alarm" and open the charging MOS at the same time.

i) Power Off Vol.

The Power Off Vol. indicates the lowest working voltage of the protection board. When the highest voltage of the cell in the battery pack is lower than this value, the protection board is closed. The value must be lower than "unit low-voltage protection".

j) "Max Charge Curr.", "Charge OCP Delay", "Charge OCPR Time"

When charging the battery pack, if the current exceeds the "Max Charge Curr" and the duration exceeds the time of "Charge OCP Delay", the protection board will generate "charging over-current alarm" and turn off the charging MOS at the same time. After the alarm is generated, after the time of "Charge OCPR Time", the protection board will release the charging over-current alarm and restart the charging MOS.

For example, set "Max Charge Curr." as 10A, "Charge OCP Delay" as 10s, "Charge OCPR

Time" as 50s. In the charging process, if the charging current exceeds 10A continuously for 10 seconds, the protection board will generate "charging over-current alarm" and close the charging MOS. 50 seconds after the alarm is generated, the "charging over-current alarm" will be released. At the same time, the protection board will restart the charging MOS.

k) "Max Discharge Curr.", "Discharge OCP Delay", "Discharge OCPR Time"

When the battery pack is discharged, when the current exceeds the "Max Discharge Curr." and the duration exceeds the time of "Discharge OCP Delay", the protection board will generate a "discharge over-current alarm" and close the discharge MOS at the same time. After the alarm is generated, after the time of "Discharge OCPR Time", the protection board releases the "discharge over-current alarm" and turns on the discharge MOS again.

For example, set "Max Discharge Curr." as 100A, "Discharge OCP Delay" as 10s, "Discharge OCPR Time" as 50s. During the discharge process, if the discharge current exceeds 100A continuously for 10 seconds, the protection board will generate a "discharge over-current alarm" and turn off the discharge MOS. 50 seconds after the alarm is generated, the "discharge over-current alarm" will be released, and the protection board will restart the discharge MOS.

l) SCPR Time

When the short-circuit protection occurs, the short-circuit protection will be released after the set time of "SCPR Time".

m) Max Balance Cur.

The balance current represents the continuous current of high-voltage battery discharge and low-voltage battery charging in the process of energy transfer.

The maximum balance current is the maximum current in the process of energy transfer, and the maximum balance current should not exceed 0.1C. For example: 20Ah battery shall not exceed $20 * 0.1 = 2A$.

n) "Charge OTP", "Charge OTPR"

During the charging process, when the battery temperature exceeds the value of "Charge OTP", the protection board will generate a "charging over temperature protection alarm", and the protection board will turn off charging MOS. After the alarm is generated, when the temperature is lower than "Charge OTPR", the "charging over temperature protection alarm" will be released, and restart the charging MOS.

o) "Charge UTP", "charge UTPR"

During the charging process, when the battery temperature is lower than the value of "Charge UTP", the protection board will generate a "low temperature protection for charging alarm", and the protection board will turn off the MOS for charging. After the alarm is generated, when the temperature is higher than "charge UTPR", the protection board will release the warning of "low temperature protection of charging alarm" and restart the MOS of charging.

p) "MOS OTP", "MOS OTPR"

When the MOS temperature exceeds the value of "MOS OTP", the protection board will generate "MOS over temperature alarm" and close the charge discharge MOS at the same time. The battery cannot be charged or discharged. After the alarm is generated and the MOS temperature is lower than the value of "MOS OTPR", the protection board will release the "MOS over temperature alarm" and restart the charge and discharge MOS (the MOS over temperature protection value is 100 °C, the MOS over temperature recovery value is 80 °C, these two values are factory default values and cannot be modified).

Attention:

Any parameter modification, please refer to the manual, improper parameters may make the protection board can not work properly, or even burn the protection board.

After any parameter is modified, you need to click "small aircraft" behind the parameter to complete parameter distribution. After the equalizer successfully receives the parameter,

it will send out a "drip" sound.

5.3.4 BMS Control

The BMS control page is shown in the figure 34. Through BMS control, the charging function, discharging function and balancing function of the protection board can be switched on and off, and the power supply of the protection board can be closed and factory Settings can be restored.

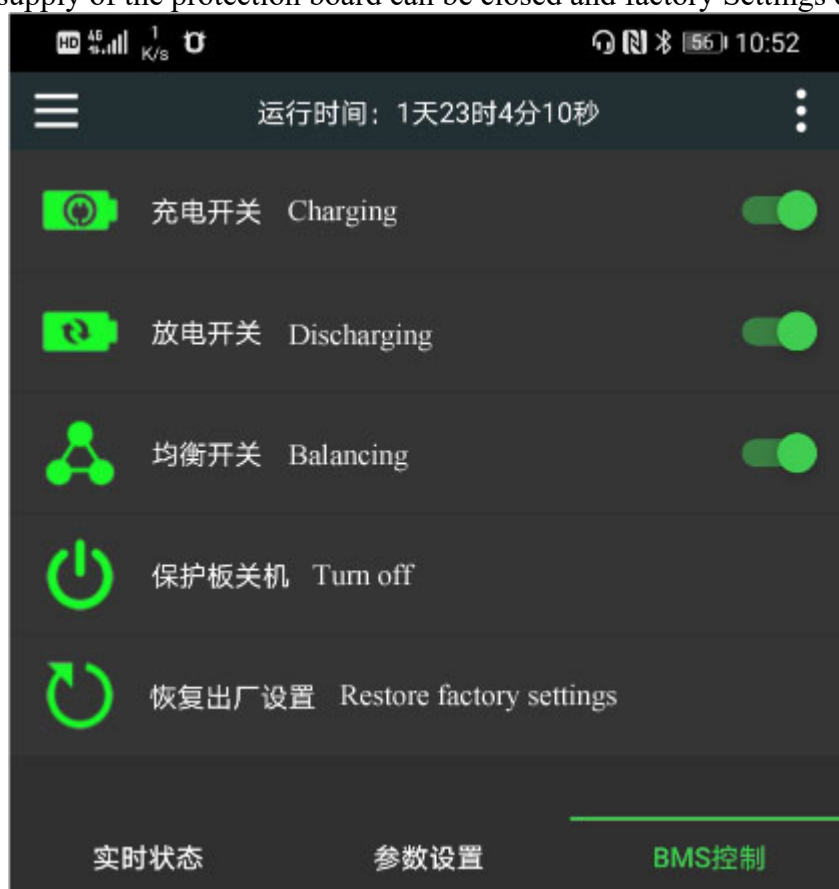

Figure 34. The BMS control page

6 Safety Protection Measures and Precautions

The protection board itself does not have high voltage, which will not cause electric shock to the body.

Please read the instruction manual carefully before use, connect according to the correct wiring diagram of different strings, and connect from the negative pole to the positive pole. After the balanced wire is connected, confirm it with a multimeter again, and insert the protection board after confirmation.

It is not allowed to modify the power line of the protection board without permission. Unauthorized modification of the power line will cause the protection board to overcurrent and burn the protection board.

7 Transportation and Storage

7.1 Transport

The products after packing are not directly affected by the rain, snow and violent bump, it can be transported by normal means of transportation. It is not allowed to put together with acid, alkali and other corrosive substances during transportation

7.2 Storage

The packed products shall be stored in a permanent warehouse with a temperature of 0 °C ~ 35 °C and a relative humidity of no more than 80%. There should be no acid, alkali and corrosive gas in the storeroom, no strong mechanism vibration and shock, and no strong magnetic field.

Appendix "one bond lithium iron", "one bond ternary" and "one bond lithium titanate" default parameters

No.	Parameter	Lithium Iron Default	Ternary Lithium Default	lithium titanate Default	Unit
1	Cell Low-voltage Protection	2.9	2.6	1.8	V
2	Cell Low-voltage Protection Recovery	3.2	3.0	2.0	V
3	Cell Overcharge Voltage	4.2	3.6	2.7	V
4	Cell Overcharge Protection Recovery	4.1	3.4	2.4	V
5	Trigger Balance Differential Voltage	0.01	0.01	0.01	V
6	Power Off Voltage	2.8	2.5	1.7	V
7	Charge Over-Current Protection	30	30	30	S
8	Charge Over-Current Protection Recovery Time	60	60	60	S
9	Discharge Over-Current Protection Delay	30	30	30	S
10	Discharge Over Current Protection Recovery Time	60	60	60	S
11	Short Circuit Protection Recovery Time	60	60	60	S
12	Charge Over Temperature Protection	60	60	60	°C
13	Charging Over Temperature Protection Recovery	55	55	55	°C
14	Discharge Over Temperature Protection	60	60	60	°C
15	Discharge Over Temperature Protection Recovery	55	55	55	°C
16	Charging Low Temperature Protection	-20	-20	-20	°C

17	Charging Low Temperature Protection Recovery	-10	-10	-10	°C
18	MOS Over Temperature Protection	75	75	75	°C
19	MOS Over Temperature Protection Recovery	70	70	70	°C